

# Regulation of tree squirrel populations with immunocontraception: a fox squirrel example

**SARA K. KRAUSE**, Department of Wildlife, Fish, and Conservation Biology, University of California, One Shields Avenue, Davis, CA 95616, USA [skkrause@ucdavis.edu](mailto:skkrause@ucdavis.edu)

**DOUGLAS A. KELT**, Department of Wildlife, Fish, and Conservation Biology, University of California, One Shields Avenue, Davis, CA 95616, USA

**DIRK H. VAN VUREN**, Department of Wildlife, Fish, and Conservation Biology, University of California, One Shields Avenue, Davis, CA 95616, USA

**JAMES P. GIONFRIDDO**, USDA, APHIS, Wildlife Services' National Wildlife Research Center, 4101 LaPorte Avenue, Fort Collins, CO 80521, USA

**Abstract:** Tree squirrels (*Sciurus* spp.) are highly successful immigrants to urban and suburban areas in North America and Europe, causing both economic and ecological damage. Control of such invasive populations is challenging but of increasing importance to local managers. We studied an invasive population of fox squirrels (*S. niger*) and applied an immunocontraceptive vaccine in an experimental study of demographic control. Here we integrate our data into a simple stage-structured population model to simulate population reduction under 2 treatment levels (60 and 80% of females, respectively) for vaccines lasting from 1 to 5 years. Contraception can be an effective means of reducing fox squirrel populations if the vaccine is effective for  $\geq 2$  years or if  $\geq 71\%$  of the females are treated. Over a 15-year period, fewer individuals require treatment at a treatment rate of 0.8 versus 0.6 due to a declining population size. This study illustrates how a simple population model may guide local resource managers in the design of control strategies for invasive species.

**Key words:** eastern fox squirrel, GonaCon™, human–wildlife conflicts, invasive species, population control, population model, *Sciurus niger*, wildlife contraception

**TREE SQUIRRELS** are highly successful invaders in urban and suburban areas. Globally, 9 species from 3 genera have successfully established populations in areas beyond their native range (Palmer et al. 2007). In the United States, both eastern gray squirrels (*Sciurus carolinensis*) and fox squirrels (*S. niger*; Figure 1) have proven to be adaptable and successful invaders. Both are native to the eastern United States; the former has invaded the western United States, Ireland, Italy, and South Africa (Koprowski 1994a, Long 2003), while the latter has been successfully introduced to the western United States where it currently is expanding its range (King 2004, Muchlinski et al. 2009).

The success of tree squirrels' invasions is probably due to their high adaptability, high fecundity, tolerance for a broad range of climatic conditions, and diverse diet (Palmer et al. 2007). The consequences of invasion by tree squirrels are diverse and may be costly (Palmer et al. 2007). In the United States, fox squirrels cause widespread agricultural damage to fruit and nut crops, including almonds and walnuts, as well as avocado and citrus groves (Salmon et al. 2006). Reported infrastructure damages

include chewing electric wires and causing fires, damages to buildings (Koprowski 1994b), damages to utility covers, tables, benches, sprinkler heads, and even plastic vehicle hoods (Krause et al. 2010). Finally, in the western United States, they also pose an ecological threat to native western grey squirrels (*S. griseus*; Muchlinski et al. 2009).

The damages caused by tree squirrels warrant population control in their introduced range, but such efforts are challenging. Whereas poisons have successfully been applied to eradicate invasive populations in Britain (Sheail 1999), their application for this purpose is not legal in the United States. Other traditional methods of control include trapping, shooting, and habitat modification, all of which are problematic in urban and suburban areas due to both the unpopularity of lethal control methods when applied to charismatic species and to human preferences for planned, tree-lined landscapes, which are ideal habitat for tree squirrels (Krause et al. 2010). Wildlife contraception offers a nonlethal alternative for tree squirrel population control. One such method is application of GonaCon™, an



**Figure 1.** Fox squirrel (*Sciurus niger*, photo courtesy of Alex Bennett).

immunocontraceptive vaccine developed by the USDA National Wildlife Research Center. GonaCon has been tested on several wildlife species, including tree squirrels; it is highly effective in reducing reproductive activity in eastern gray squirrels (Pai et al. 2011) and fox squirrels (Krause et al. 2014).

Because assessing population-level effectiveness in the field often is both expensive and time consuming, previous contraceptive studies have concentrated on individual rather than population-level effectiveness. Researchers and managers have used population models to simulate the potential effectiveness of contraception in the field. Most approaches use age- or stage-structured models (Boone and Wiegert 1994, Shi et al. 2002, Merrill et al. 2003, Grund 2011). Although other approaches include logistic models (Barlow et al. 1997), steady-state models (Zhang 2000, Liu et al. 2012), which are commercially available software, such as Generalized Animal Population Projection, also are used (Seagle and Close 1995).

The number of parameters required and considered for different models varies greatly. All of the models with which we are familiar require estimates of survival and reproduction for  $\geq 1$  stage or age. Some incorporate density-dependence for 1 or both of these factors, although the number of stages and the types of reproductive estimate used (i.e., birth rate or recruitment rate) vary. Most models do not consider immigration, and, technically, they are

appropriate only for closed populations (for an open population model, see Zhang 2000). When choosing or developing a population model, the inclusion of more demographic parameters may result in a more realistic model, but only if these parameters are properly estimated; errors in parameter estimation will result in proportional errors in model output. Therefore, simple models have been developed to allow simulation of populations where few parameters are available (e.g., Hobbs et al. 2000).

We apply a population model to simulate the potential effectiveness of GonaCon for control of a fox squirrel population that has invaded the University of California–Davis (UCD) campus. We developed a density-independent, stage-structured model (Lefkovitch 1965) modified from the density-dependent demographic model developed by Hobbs et al. (2000) for ungulate populations. This model has the advantage of requiring few estimated parameters. To provide the most useful guidance to resource or facilities managers, we simulate the population size using 2 contraceptive treatment rates over a 20-year period and provide an estimate of numbers of squirrels requiring treatment. Comparing the potential population results and treatment input required for the 2 treatment rates will help managers quickly and easily assess the cost and effectiveness of tradeoffs inherent in management goals.

## Study area

We studied a population of fox squirrels on the UCD campus, a mosaic of buildings, lawns, paved paths and roads, shrubbery, and mature trees, including oaks (*Quercus* spp.) and pines (*Pinus* spp.). Fox squirrels arrived on the UCD campus circa 2001 and reached approximately 1,600 individuals by 2009, when the first population estimate was conducted (Krause et al. 2010). Parameters for our model were obtained through trapping efforts in 2 similar areas of the campus. The first area was dominated by academic buildings, and the second was dominated by student housing. Both areas were heavily frequented by people and had similar densities of fox squirrels.

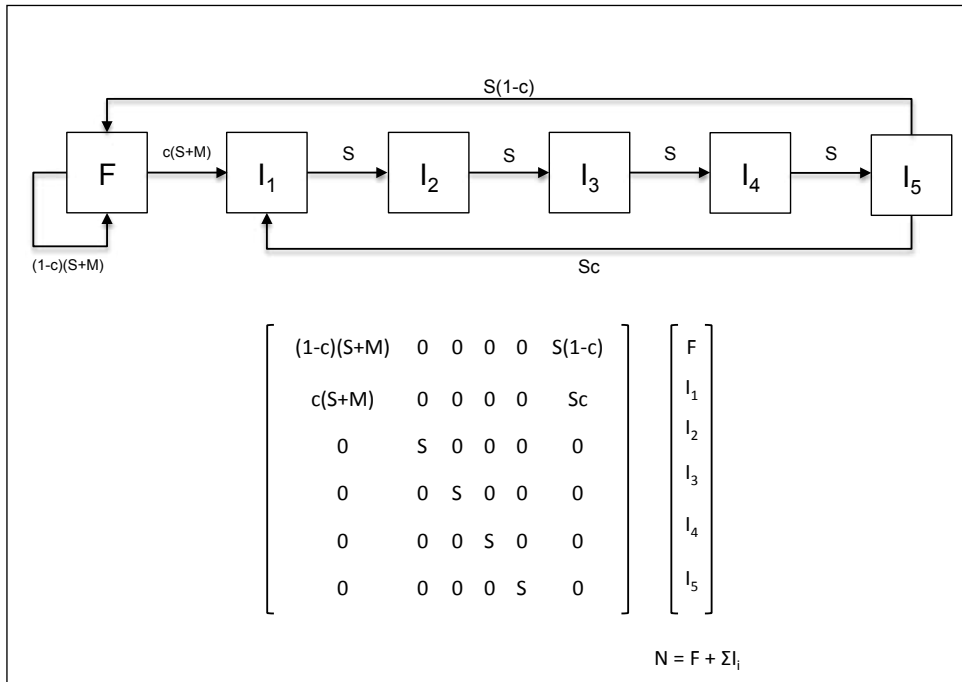

**Figure 2.** Structure of the stage-structured population used to simulate a fox squirrel (*Sciurus niger*) population regulated with a contraceptive with a 5-year duration (modified from Hobbs et al. 2000). The model contains 6 age classes: fertile females (F) and infertile females in years 1 through 5 ( $I_1, I_2, I_3, I_4, I_5$ ). M indicates the recruitment rate of new individuals to the adult female population; S = survival rate;  $\hat{c}$  = treatment rate.

### Methods

#### Study species and estimation of demographic parameters

Demographic parameters used in our model were estimated using data from the literature and from a contraception field study conducted on the UCD fox squirrel population from November 2008 to December 2010 (Krause et al. 2014). This study included seasonal captures, reproductive assessments, marking, and field observations of 116 treated (including control) fox squirrels, as well as capture and reproductive assessment of an additional 210 untreated squirrels (Krause et al. 2014). Contraception treatments were applied during July 2009.

Similar to populations elsewhere, fox squirrels at UCD have 2 breeding seasons per year (peaks near January and June), and at least some individuals breed twice annually (Krause et al. 2014). However, several studies suggest that such bimodal breeding is uncommon and most individuals breed only once per year (Koprowski 1994b). We used the simplifying assumption that all individuals reached maturity immediately prior to treatment. In our

model, we estimated  $M = N^*_{t+1}/N_t$ , where  $N^*_{t+1}$  = the number of new adult females at time  $t+1$ , and  $N_t$  = the number of adult females at time  $t$ . For our study,  $N^*_{2009} = 34$ , and  $N^*_{2008} = 29$ ; hence,  $M = 1.17$  (where  $M$  = recruitment to maturity rate). Note that juvenile and subadult survival are subsumed within  $M$ . This is necessary because juvenile and subadult survival rates are challenging to calculate because these individuals often die before ever being trapped. Although immigration and emigration could influence this value, this would be problematic only in the case of unequal migration.

In our model, female fox squirrels were treated with GonaCon upon reaching adult size, which can occur as early as 6 months of age, although maturity usually occurs between 12 and 18 months of age (McCloskey 1977). We estimated survival rate for our model based on values reported in the literature, and to make our model conservative we used the highest known values (66%; Table 1).

#### Population model

As noted above, we used a density-independent, stage-structured model (Lefko-

**Table 1.** Annual survival rates of male and female fox squirrels (*Sciurus niger*) extracted from the literature.

Source		Male survival rate	Female survival rate	Combined survival rate
Conner (2001)		0.73	0.66	0.69
McCleery et al. (2008)	Urban	0.30	0.40	0.75
	Rural	0.87	0.53	0.51
	Combined	0.51	0.51	0.59
Hansen (1986) <sup>a</sup>		0.66	0.63	0.65
Lee et al. (2008)		0.62	0.62	0.62
Mean		0.62	0.56	0.63
Range		0.30–0.73	0.40–0.66	0.51–0.75

<sup>a</sup>Hansen provided disappearance rate. Values presented here are 1-MH, where MH refers to the disappearance rates provided by Hansen.

vitch 1965) similar to Hobbs et al. (2000); Figure 2). Females were treated as fertile or infertile; males were not included in the model. Because the effective duration of the vaccine is not known in fox squirrels (but is  $\geq 17$  months; Krause et al. 2014), we ran separate models, assuming durations of 1 through 5 years, with infertile females split into age classes according to the number of years since vaccination ( $I_1$  through  $I_5$ ). This model assumes that researchers both know when an individual last received a vaccine and that individuals are revaccinated only after the efficacy of the vaccine has declined. Parameters required by the model include annual survival rate ( $S$ ), recruitment to maturity rate ( $M$ ), and annual treatment rate ( $c$ ).

We assumed that each yearly population estimate occurred immediately prior to the summer breeding season and that contraception treatment was given once per year at this time. We also used annual values for survival and recruitment to maturity rates.

**Testing the model.** We tested our model by setting the treatment rate ( $c$ ) to 0 and the initial population of females to 10; we used survival and recruitment to maturity terms as noted above (e.g.,  $S = 0.66$ ,  $M = 1.17$ ). We expected the model to reflect the population dynamics of the real squirrel population at UCD that reached approximately 800 females within 8 years.

**Determinate model simulations.** We simulated the effectiveness of contraception under 2 treatment levels (60 and 80% of females) and 5 contraception durations (1 to 5 years). Treatment levels reflect known capture

rates for female fox squirrels on the UCD campus (Krause et al. 2014). Contraceptive durations were chosen because our data indicate that GonaCon remains effective in fox squirrels for  $\geq 17$  months (Krause et al. 2014), but it is known to last  $\leq 5$  years in other species (Levy et al. 2011). We calculated the projected population of females over a period of 20 years, the population size at 5 years versus the treatment rate used, and the estimated number of individuals requiring treatment in the first, second, and third 5-year treatment periods.

**Incorporating stochasticity.** We incorporated demographic stochasticity into these models to provide a range of realistic outputs. Although we could estimate species-specific stochasticity for survival from the literature, we are concerned that this may not be a good representation of the variability inherent in a single population. Consequently, we applied a more general approach of implementing yearly stochasticity by adjusting the population size as  $N+N\sigma$ , where  $N$  = population size and  $\sigma$  is a variate from a normal distribution with a mean = 0 and standard deviation = 0.1 for each year of the simulation. Simulations were run 1,000 times.

Because rates of survival and recruitment to maturity are spatially and temporally variable, we simulated the potential population size at year 5 using a range of rates for these parameters. We used a starting population of 800 females with a constant treatment rate of 0.6. We varied survival rate from 0.40 to 0.66, the known range of female survival rates

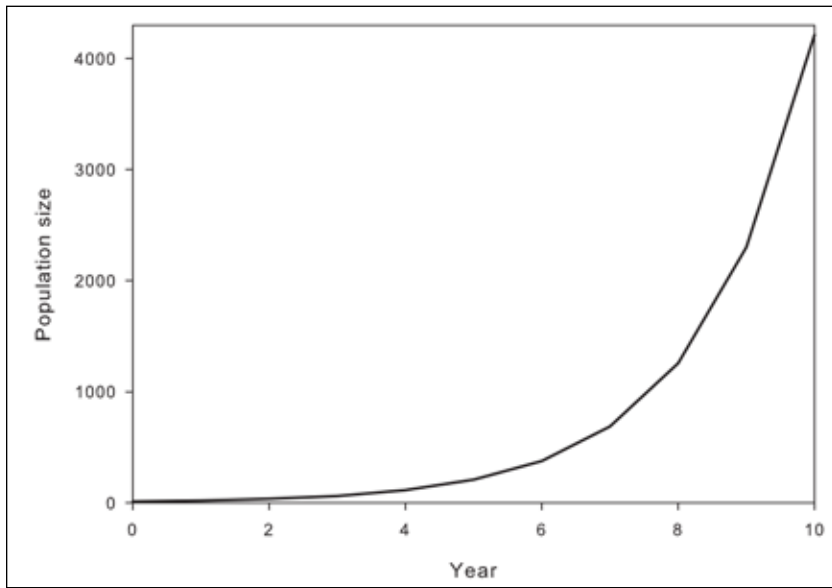

**Figure 3.** Simulated growth of females in a fox squirrel (*Sciurus niger*) population over an 8-year period, with an initial population of 10 females,  $S = 0.66$ ,  $M = 1.17$ .

(Table 1) and used a constant  $M = 1.17$ . No data were available on the potential variation of the recruitment to maturity rate, but we suspect that this value may be highly variable. Therefore, we simulated the population using a range of  $M \pm 50\%$  of our calculated value of 1.17 (e.g.,  $0.58 < M < 1.76$ ) and a constant  $S = 0.66$ .

## Results

### Testing the model

When beginning with an initial population of 10 females,  $S = 0.66$ , and  $M = 1.17$ , the projected population reached 800 females between years 7 and 8 (Figure 3). Since this is within the 8-year period during which the UCD fox squirrel population reached this abundance (Krause et al. 2014), we considered our model adequate for testing the effectiveness of contraception in the population.

### Model simulations

Higher treatment levels and longer vaccine duration resulted in the largest and fastest population declines. Simulations suggest that at a treatment rate of 0.6, the population will continue to increase using a 1-year duration vaccine, slowly decrease with a 2-year duration vaccine, and decrease more rapidly with 3-, 4-, and 5-year duration vaccines (Figure 4). At a treatment level of 0.8, all vaccine durations

were effective in reducing the population of fox squirrels (Figure 4). Additionally, simulations suggest that achieving a population reduction from a population of 800 females within a 5-year period using a 1-year-duration vaccine requires a treatment rate of  $\leq 0.71$ , while a 5-year-duration vaccine requires a treatment rate of 0.55 (Figure 5). Stochastic simulations indicated that a 0.6 treatment level with a 2-year-duration vaccine may not result in a reduced population, but all longer duration vaccines and the higher treatment level resulted in declining populations (Figure 6). While a higher treatment rate requires greater investment (e.g., more vaccinations) in the first 5 years, the total investment over a longer time period (e.g., 15 years) was lower because population size declined more rapidly (Figure 7).

With  $M = 1.17$ , estimates of model output with varying of  $S$  indicate that population size would increase by year 5 if  $S > 0.53$  using a 1-year vaccine, or with  $S > 0.64$  using a 2-year vaccine; all other scenarios resulted in a reduced population size (Figure 8). When we hold  $S = 0.66$  and varied  $M$ , simulations indicate that a 1-year-duration vaccine will reduce the population only if  $M < 0.85$ , while a 5-year-duration vaccine will result in population reduction for any  $M < 1.40$  (Figure 8).

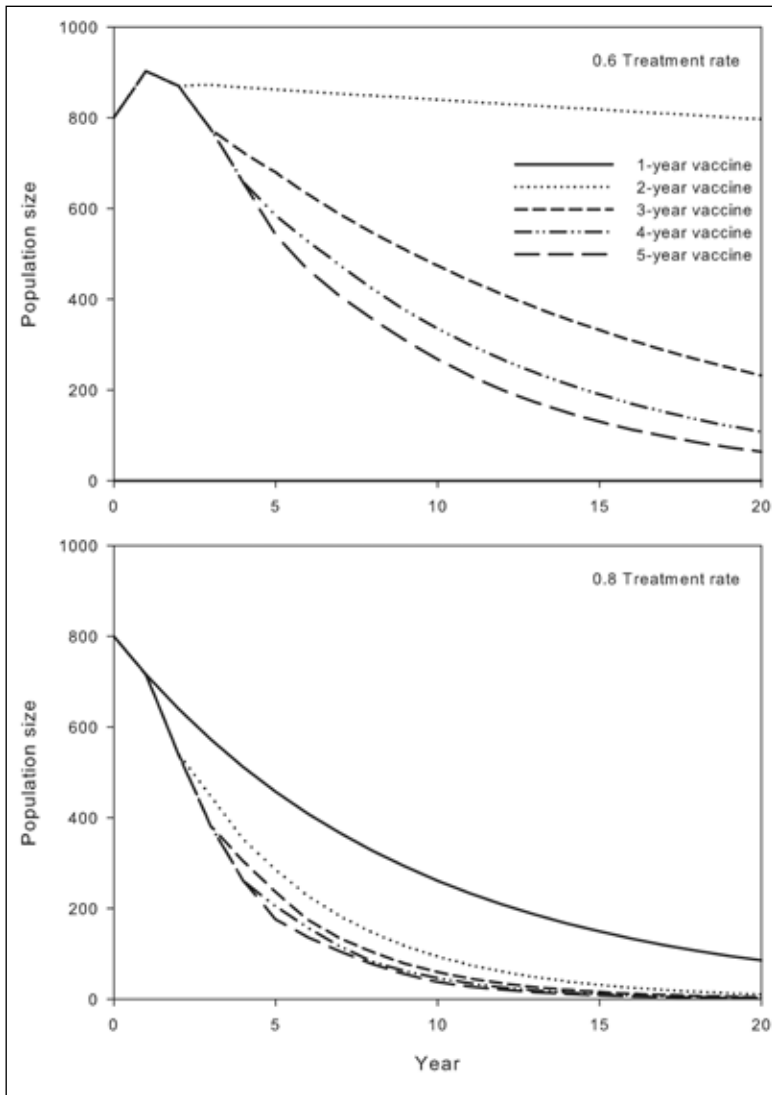
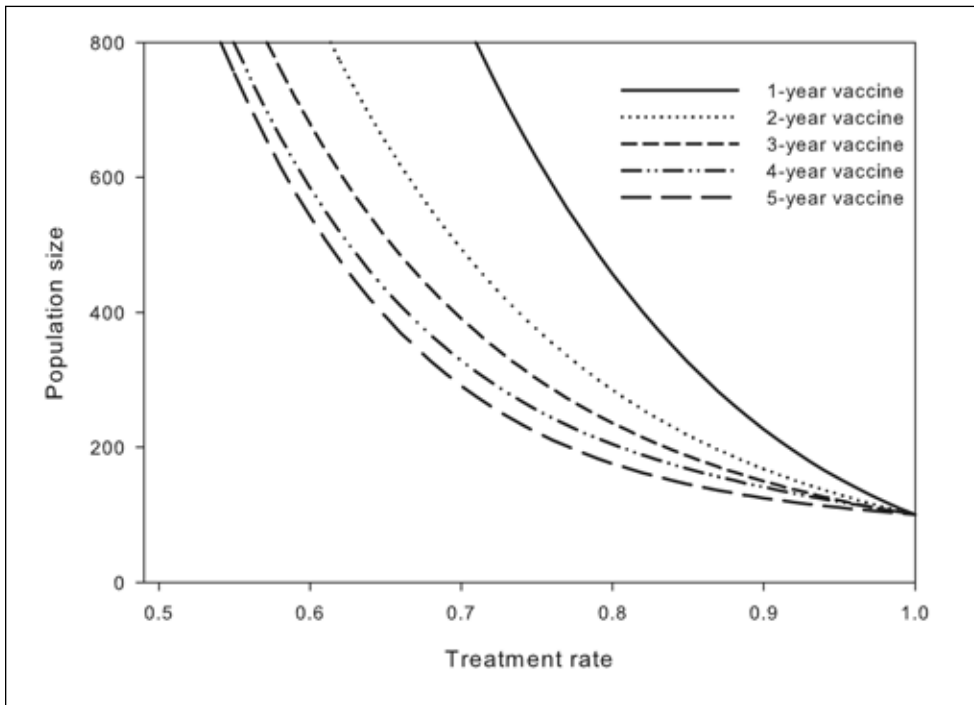

**Figure 4.** Simulated population over 20 model-years of female fox squirrels (*Sciurus niger*) under 5 different durations and 2 different treatment rates of contraception with an initial population size of 800,  $S = 0.66$ , and  $M = 1.17$ . The top graph does not include the 1-year-duration vaccine because the population continued to increase for this treatment.

## Discussion

Work reported here is part of a broader study on the efficacy of immunocontraception in fox squirrels, in which we documented that GonaCon inhibits reproduction in male and female squirrels for  $\geq 3$  breeding seasons (Krause et al. 2014). Modeling efforts presented here indicate that contraception can be an effective means of reducing fox squirrel populations if the vaccine is effective for  $\geq 2$  years or if  $\leq 71\%$  of the females are treated. Not surprisingly, longer duration vaccines should be more effective than shorter duration vaccines; also not surprisingly,

but, important to managers, a higher initial treatment rate reduces the total investment (e.g., number of animals requiring treatment, hence, amount of GonaCon and number of hours of labor) because initial demographic reduction reduces the number of animals entering the reproductive pool in future years. These results are promising for the potential future use of GonaCon or other contraceptives for tree squirrel population control. Our results also should be applicable to other urban and suburban tree squirrel populations, assuming similar survival and recruitment to maturity rates.



**Figure 5.** Simulated population size of adult female fox squirrels (*Sciurus niger*) after 5 years of contraceptive treatment at different treatment rates and for a vaccine lasting 1, 2, 3, 4, or 5 years with an initial population size of 800 adult females,  $S = 0.66$ , and  $M = 1.17$ . The ordinate extends only to 800 because any values above this reflect population growth rather than decline, and, hence, represents a failed treatment regime.

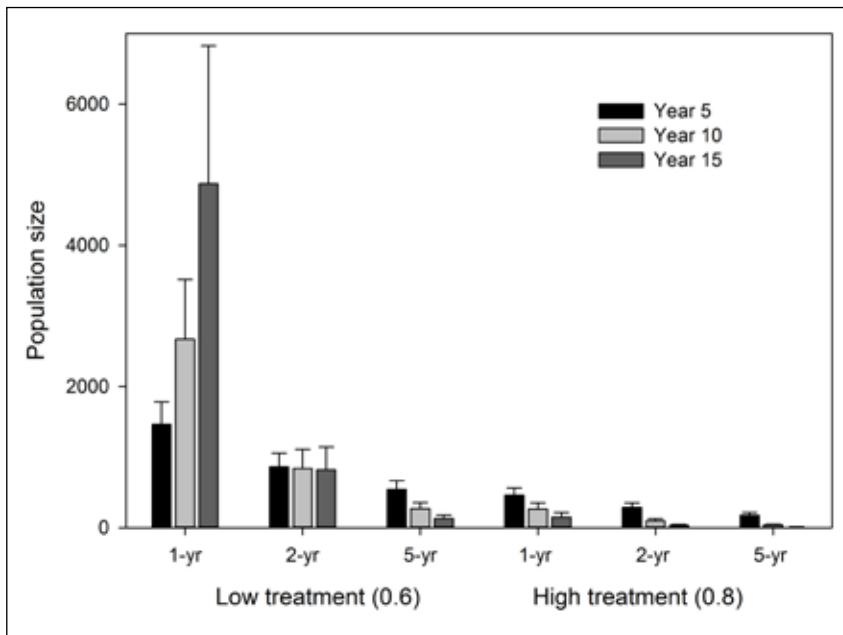

**Figure 6.** Simulated population size of female fox squirrels (*Sciurus niger*) treated with contraception for population management after 5, 10, and 15 years at 2 different treatment levels (0.6 and 0.8) and 3 different contraception durations (1, 2, and 5 years). Error bars indicate standard deviation from 1,000 stochastic simulations.

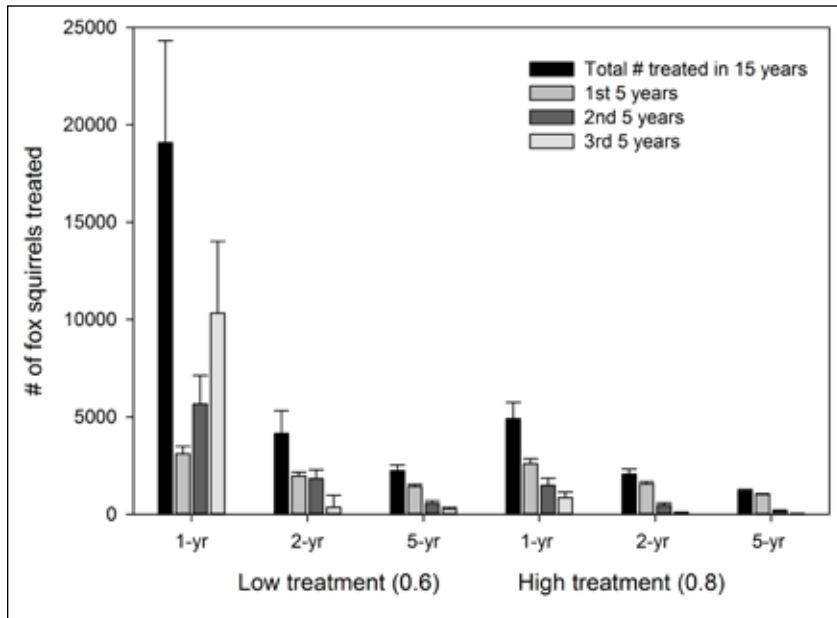

**Figure 7.** Simulated number of female fox squirrels (*Sciurus niger*) treated with contraception for population management over a period of 15 years, using a deterministic population model. Simulations with low treatment and a 1-year-duration vaccine have a very different trajectory than all other simulations, because the population continues to increase so more squirrels are treated in each year. Error bars indicate standard deviation from 1,000 stochastic simulations.

To our knowledge, this is the first study to address the population-level effectiveness of contraception in tree squirrels. Most contraception population models have been developed for ungulate populations (Boone and Wiegert 1994, Seagle and Close 1995, Hobbs et al. 2000, Bradford and Hobbs 2008), many of which are well-known, allowing for highly accurate and detailed estimates of a variety of demographic parameters used in models. Such demographic data are not available for most species, including fox squirrels; we circumvented this constraint by using a model that requires few parameters, all of which could be obtained from the literature or our short-term data set. Because further research is needed to determine how long contraception remains effective in fox squirrels, we provide a range of possible outcomes for different contraceptive durations.

Lethal control has been available for many years but is not always viable. Where it is an option, it may complement contraceptive control in invasive populations (Hobbs et al. 2000, Shi et al. 2002, Grund 2011, Liu et al. 2012). However, Brandt's voles (*Microtus brandti*) were more effectively controlled by regulating

fertility than by lethal approaches (Shi et al. 2002), and a combination of lethal and fertility control was more effective than either method alone for koalas (*Phascolarctos cinereus*; Tanaka et al. 2009) and white-tailed deer (*Odocoileus virginianus*; Hobbs et al. 2000). Further studies are needed to determine the efficacy of lethal versus contraceptive control for tree squirrels.

The accuracy of any model is dependent upon input parameters. Our model included only 2 demographic parameters:  $S$  and  $M$ . One benefit of this is that the model could be applied to many other populations for which extensive data are unavailable. For our study system, survival rates vary among populations of fox squirrels (Table 1), but the causes for much of the variation are not fully understood. Limited evidence suggests that urban fox squirrel populations may have higher and more variable survival than do rural populations (Conner 2001, McCleery et al. 2008). In our model, we used the highest value of  $S$  reported in the literature. This choice creates a bias in our model, such that real populations should be more responsive to contraception than indicated in our model. The rate of recruitment to maturity is easily calculated with most



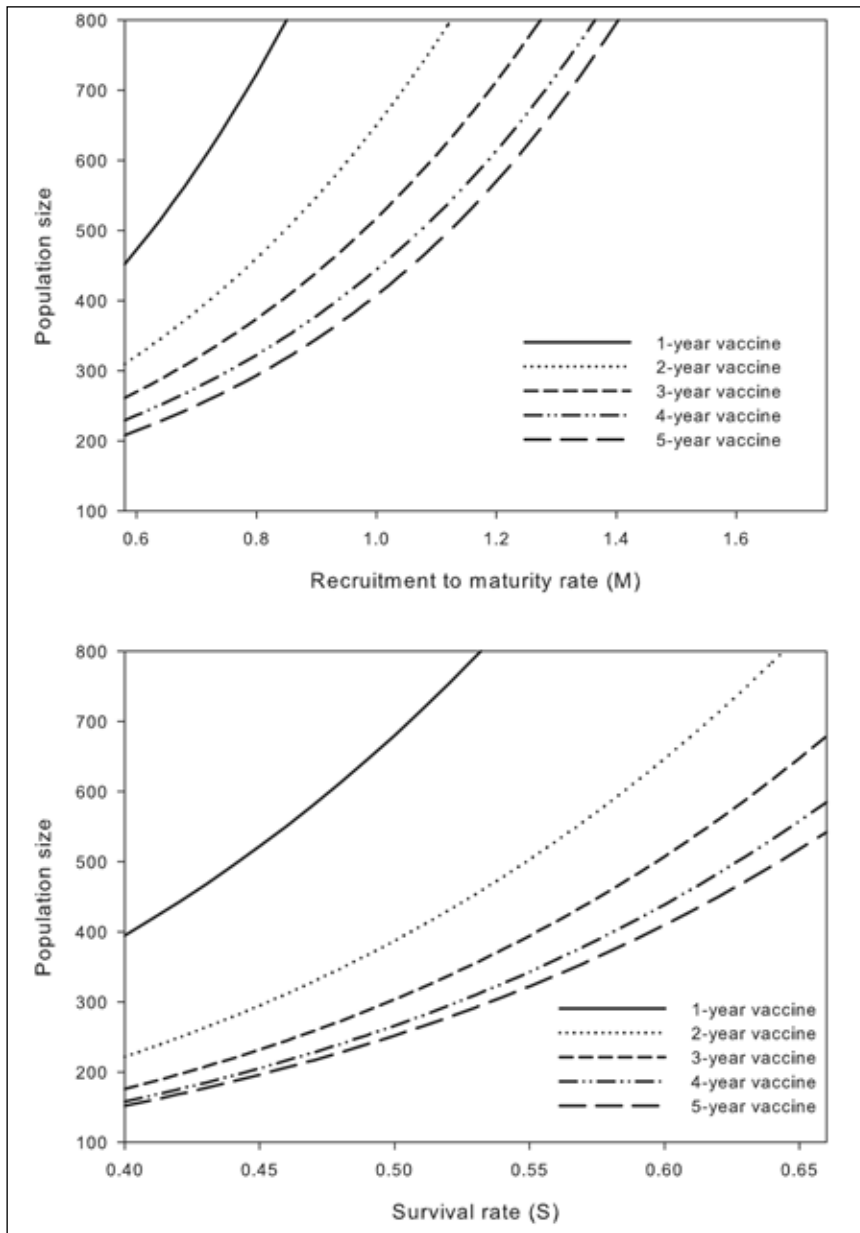

**Figure 8.** Simulated population size of adult female fox squirrels (*Sciurus niger*) after 5 years of contraceptive treatment for a vaccine lasting 1, 2, 3, 4, or 5 years with an initial population size of 800 adult females and treatment rate ( $c$ ) of 0.6. The ordinate extends only to 800 because any values above this reflect population growth rather than decline, and hence represents a failed treatment regime. The upper panel shows a range of recruitment to maturity rates with  $S = 0.66$ . The lower panel shows a range of survival rates with  $M = 1.17$ .

trapping data sets but ultimately is dependent upon the reproductive rate and the juvenile survival rates, which may not be directly related. Therefore, the recruitment to maturity rate may be highly variable. Reproductive rates may vary annually and seasonally (Weigl et al. 1989, Krause et al. 2014), and little is known about the variation in juvenile and subadult

survival rates. Simulations reported here indicate that variation in estimated parameters can have a large effect on population size, especially when vaccine duration is short (Figure 8). Currently, more data are required to accurately model the extent of variation in survival or recruitment to maturity rates, so we encourage appropriate caution in interpreting

these models, and we recommend monitoring survival and recruitment to maturity rates in any subsequent field trials of contraceptive population control.

We made the simplifying assumption that the population was density-independent, that parameter estimates from unmanipulated populations were appropriate for the model, and that these were not influenced by contraceptive treatment. These assumptions may not be valid. Further data on survival and recruitment to maturity rates are needed to evaluate the extent and nature of density-dependence in the fox squirrel population. Barlow et al. (1997) reported that density-dependence in survival rates was more important than that in reproductive rates when controlling species with contraceptive methods. Untreated individuals of European rabbits (*Oryctolagus cuniculus*) exhibited compensatory increases in survival and recruitment in response to contraception treatments within the population (Twigg and Williams 1999) and following removal of female fox squirrels in Illinois, reproductive rate among remaining animals increased (Herkert et al. 1992). Similarly, the reproductive rate of untreated squirrels in our study population increased after treatment (Krause et al. 2014). These data suggest a causal relationship, but further work should be designed to confirm or refute this hypothesis.

Finally, our model assumed equal immigration and emigration rates of subadults prior to treatment (within  $M$ ) and that adult females do not disperse. Zhang (2000) noted that larger animals and those with lower dispersal ability should be more readily controlled with contraception than smaller animals or those with greater dispersal capabilities and that closed populations are easier to control with contraception than open populations, although these inferences have not been evaluated with data from free-living populations. Subadult male and female fox squirrels in Kansas dispersed an average of 1.10 km and 0.32 km, respectively (Koprowski 1996), and squirrels from our population have emigrated to the surrounding town of Davis, California (Krause et al. 2010). Presumably, some reciprocal immigration has occurred, as well. More data are needed to determine the effects of dispersal in fox squirrel populations, but we presume

adult dispersal occurs less frequently than juvenile dispersal. Migration would reduce the effectiveness of contraception within the treated area, although emigration of treated individuals also could suppress reproduction in surrounding areas. We do not know if treated animals are more or less likely than untreated animals to disperse, so we cannot evaluate the potential impact of violating this model assumption. Future studies should consider monitoring squirrel dispersal behavior to obtain accurate dispersal parameters for use in models incorporating dispersal.

Our simulations provide resource managers with estimates of the effectiveness of contraception and the ability to calculate the potential cost of treatment based on the expected number of animals requiring treatment. This model provides a ready means of comparing the effects of different treatment levels and indicates that GonaCon could reduce fox squirrel populations.

### Acknowledgments

S. Genito and UCD Facilities and Maintenance Services provided valuable information on the UCD fox squirrels and facility concerns. We thank A. D. Bennett for editing assistance and the numerous undergraduates for countless hours trapping and observing squirrels. Funding for this project was provided by the UCD Grounds Department and USDA National Wildlife Research Center.

### Literature cited

- Allen, D. L. 1942. Populations and habits of the fox squirrel in Allegan County, Michigan. *American Midland Naturalist* 27:338–379.
- Barlow, N. D., J. M. Kean, and C. J. Briggs. 1997. Modelling the relative efficacy of culling and sterilization for controlling populations. *Wildlife Research* 24:129–141.
- Baumgartner, L. L. 1940. The fox squirrel: its life history and management in Ohio. *Ohio State University Release* 138:1–17.
- Boone, J. L., and R. G. Wiegert. 1994. Modeling deer herd management: sterilization is a viable option. *Ecological Modelling* 72:175–186.
- Bradford, J. B., and N. T. Hobbs. 2008. Regulating overabundant ungulate populations: an example for elk in Rocky Mountain National Park, Colorado. *Journal of Environmental Management* 86:520–528.

- Brown, L. G., and L. E. Yeager. 1945. Fox squirrels and gray squirrels in Illinois. Illinois Natural History Survey Bulletin 23:449–536.
- Conner, L. M. 2001. Survival and cause-specific mortality of adult fox squirrels in southwestern Georgia. *Journal of Wildlife Management* 65:200–204.
- Goodrum, P. A. 1967. Tree squirrel investigations. Texas Game, Fish, and Oyster Commission Report 2:50–52.
- Grund, M. D. 2011. Survival analysis and computer simulations of lethal and contraceptive management strategies for urban deer. *Human–Wildlife Interactions* 5:23–31.
- Hansen, L. P. 1986. Recapture rates and length of residence in an unexploited fox squirrel population. *American Midland Naturalist* 115:209–215.
- Hansen, L. P., and C. M. Nixon. 1985. The effects of adults on the demography of fox squirrels (*Sciurus niger*). *Canadian Journal of Zoology* 63:861–867.
- Harnishfeger, R. L., J. L. Roseberry, and W. D. Klimstra. 1978. Reproductive levels in unexploited woodlot fox squirrels. *Transactions of the Illinois State Academy of Science* 70:342–355.
- Herkert, J. R., C. M. Nixon, and L. P. Hansen. 1992. Dynamics of exploited and unexploited fox squirrel (*Sciurus niger*) populations in the midwestern United States. Pages 864–874 in D. R. McCullough and R. H. Barrett, editors. *Wildlife 2001: populations*. Elsevier Applied Science, New York, New York, USA.
- Hobbs, N. T., D. C. Bowden, and D. L. Baker. 2000. Effects of fertility control on populations of ungulates: general, stage structured models. *Journal of Wildlife Management* 64:473–491.
- King, J. E. 2004. The current distribution of the introduced fox squirrel (*Sciurus niger*) in the greater Los Angeles metropolitan area and its behavioral interaction with the native western gray squirrel (*Sciurus griseus*). Thesis, California State University, Los Angeles, California, USA.
- Koprowski, J. L. 1994a. *Sciurus carolinensis*. *Mammalian Species Account* 480:1–9.
- Koprowski, J. L. 1994b. *Sciurus niger*. *Mammalian Species* 479:1–9.
- Koprowski, J. L. 1996. Natal philopatry, communal nesting, and kinship in fox squirrels and gray squirrels. *Journal of Mammalogy* 77:1006–1016.
- Krause, S. K., D. A. Kelt, J. P. Gionfriddo, and D. H. Van Vuren. 2014. Efficacy and health effects of a wildlife immunocontraceptive vaccine on fox squirrels. *Journal of Wildlife Management* 78:12–23.
- Krause, S. K., D. A. Kelt, and D. H. Van Vuren. 2010. Invasion, damage, and control options for eastern fox squirrels. *Proceedings of the Vertebrate Pest Conference* 24:29–31.
- Lee, J. C., David A. Osborn, Karl V. Miller. 2008. Characteristics of a high density population of southern fox squirrels. *American Midland Naturalist* 159:385–393.
- Lefkovich, L. P. 1965. The study of population growth in organisms grouped by stages. *Biometrika* 35:183–212.
- Levy, J. K., J. A. Friary, L. A. Miller, S. J. Tucker, and K. A. Fagerstone. 2011. Long-term fertility control in female cats with GonaCon, a GnRH immunocontraceptive. *Theriogenology* 76:1517–1525.
- Liu, H., Z. Jin, Y. Chen, and F. Zhang. 2012. Population dynamics of plateau pika under lethal control and contraception control. *Advances in Difference Equations* 2012:1–13.
- Long, J. L. 2003. *Introduced mammals of the world: their history, distribution, and influence*. CABI Publishing, Wallingford, Oxon, United Kingdom.
- McCleery, R. A., R. R. Lopez, N. J. Silvy, and D. L. Gallant. 2008. Fox squirrel survival in urban and rural environments. *Journal of Wildlife Management* 72:133–137.
- McCloskey, R. J. 1977. Accuracy of criteria used to determine age of fox squirrels. *Proceedings of the Iowa Academy of Science* 84:32–34.
- McCloskey, R. J., and P. A. J. Vohs. 1971. Chronology of reproduction of the fox squirrel in Iowa. *Proceedings of the Iowa Academy of Science* 78:12–15.
- Merrill, J. A., E. G. Cooch, and P. D. Curtis. 2003. Time to reduction: factors influencing management efficacy in sterilizing overabundant white-tailed deer. *Journal of Wildlife Management* 67:267–269.
- Muchlinski, A. E., G. R. Stewart, J. L. King, and S. A. Lewis. 2009. Documentation of replacement of native western gray squirrels by introduced eastern fox squirrels. *Bulletin, Southern California Academy of Sciences* 108:160–162.
- Pai, M., D. H. Schlafer, G. K. Yarrow, C. A. Yoder, and L. A. Miller. 2011. Immunocontraception in

- eastern gray squirrels (*Sciurus carolinensis*): morphologic changes in reproductive organs. *Journal of Zoo and Wildlife Medicine* 42:718–722.
- Palmer, G. H., J. L. Koprowski, and T. Pernas. 2007. Tree squirrels as invasive species: conservation and management implications. Pages 272–283 in G. W. Witmer, W. C. Pitt, K. A. Fagerstone, editors. *Managing vertebrate invasive species: proceedings of an international symposium*. USDA, APHIS, WS, National Wildlife Research Center, Fort Collins, Colorado, USA.
- Salmon, T. P., D. A. Whisson, and R. E. Marsh. 2006. *Wildlife pest control around gardens and homes*. Second edition. University of California, Oakland, California, USA.
- Seagle, S. W., and J. D. Close. 1995. Modeling white-tailed deer *Odocoileus virginianus* population control by contraception. *Biological Conservation* 76:87–91.
- Sheail, J. 1999. The grey squirrel (*Sciurus carolinensis*)—a UK historical perspective on a vertebrate pest species. *Journal of Environmental Management* 55:145–156
- Shi, D., X. Wan, S. A. Davis, R. P. Pech, and Z. Zhang. 2002. Simulation of lethal control and fertility control in a demographic model for Brandt's vole *Microtus brandti*. *Journal of Applied Ecology* 39:337–348.
- Tanaka, M. M., R. Cristescu, and D. W. Cooper. 2009. Effective population size of koala populations under different population management regimes including contraception. *Wildlife Research* 36:601–609.
- Twigg, L. E., and K. C. Williams. 1999. Fertility control of overabundant species: can it work for feral rabbits? *Ecology Letters* 2:281–285.
- Weigl, P. D., M. A. Steele, L. J. Sherman, J. C. Ha, and T. L. Sharpe. 1989. The ecology of the fox squirrel (*Sciurus niger*) in North Carolina: implications for survival in the southeast. *Bulletin of the Tall Timbers Research Station* 24:1–93.
- Zhang, Z. 2000. Mathematical models of wildlife management by contraception. *Ecological Modelling* 132:105–113.

**SARA K. KRAUSE** is a wildlife ecologist at the University of California–Davis (UCD) in the Wildlife, Fish, and Conservation Biology Department. She received her B.S. degree in natural resources at Cornell University and expects to complete her Ph.D. degree at UCD during summer 2014. She has conducted research on a variety of wildlife species and has a keen interest in squirrel ecology. Her teaching and research interests include wildlife ecology, conservation, and management.



**DOUGLAS A. KELT** is a professor of wildlife ecology at the University of California–Davis. He has 2 B.S. degrees from Humboldt State University (zoology, botany), an M.S. degree in biology from Northern Illinois University, and a Ph.D. degree in biology from the University of New Mexico. He studies the ecology, biogeography, and conservation of mammals, with an emphasis on small mammals in arid lands and forests of North and South America. Recent efforts have focused on small mammal responses to forest management in the Sierra Nevada and a long-term experimental manipulation in semiarid regions of northern Chile.



**DIRK H. VAN VUREN** is a professor of wildlife biology in the Department of Wildlife, Fish, and Conservation Biology at the University of California–Davis. He earned his B. A. degree in zoology from the University of California–Berkeley, his M. S. degree in wildlife science from Oregon State University, and his Ph.D. degree in systematics and ecology from the University of Kansas. His research focuses on human–wildlife conflicts, exotic species, and mammalian ecology and conservation.



**JAMES P. GIONFRIDDO** (photo unavailable) is a wildlife research biologist, retired from USDA's National Wildlife Research Center in Fort Collins, Colorado. He received B.S. and M.S. degrees in wildlife ecology from the University of Arizona and a Ph.D. degree in ecology and evolutionary biology from Iowa State University. His research interests include wildlife contraception and vertebrate behavioral ecology.