

## Application of Raman Spectroscopy To Small Satellites in Exploring Solar Bodies

*James Cantrell  
Greg McCurdy  
Utah State University*

Raman Spectroscopy is an active remote sensing method that can map planetary mineral and chemical abundances and their distributions. Raman spectroscopy can also be used to study the chemical composition of various planetary atmospheres. The remote raman technique utilizes a low power laser to stimulate raman scattering at the substance and a spectrometer receives the returned raman spectrum at the spacecraft. The returned spectrum contains the shifts in frequency, shifted from that of the incident laser light, that are characteristic of the substance. The intensity of the raman spectrum lines is proportional to the amount of the substance present. Thus, with raman spectral information, the identification of a substance and an estimate of its volumetric concentrations can be achieved. The baseline remote raman instrument system utilizes a 10 W krypton laser and a HIRIS spectrally sensitive detector array, cassegrain optics, has a mass of 200 Kg, and consumes 1 KW of electrical power.

This paper explores the basic concepts of remote raman spectroscopy and postulates an instrument package that is compatible with the mass and size constraints of a small satellite. Various solar system exploratory missions using raman spectroscopy are discussed including the study of the surface of the moon, Earth's upper atmosphere, the atmosphere of Mars, the atmosphere of Jupiter, and the rings of Saturn.

### INTRODUCTION

The raman effect, otherwise known as raman scattering, was first observed in the 1940's and has in recent years found widespread use in laboratory applications. The popularity of laboratory raman spectroscopy during the last twenty years is due to the advent of a monochromatic light source, the laser, and advances in detector technology. For many years now, the raman effect has been used to study molecular and crystal structures of substances in the laboratory and a large amount of data has been compiled on the raman spectra of a wide variety of organic and inorganic substances. Raman spectroscopy has also been applied to the analysis of extraterrestrial materials such as the Apollo moon rocks<sup>10</sup>.

The application of raman spectroscopy to remote sensing on Earth has been very limited to date due mostly to the very weak nature of raman emissions which is further complicated by distance and the presence of an atmosphere. Despite this, some pollution studies have been performed using raman spectroscopy and have met with limited success<sup>9</sup>. The recent advances in high power laser, spectral detector array, and filter technologies enable the raman scattering principle to be more successfully applied to remote sensing applications both on Earth and to solar bodies in general. The combination of the lack of an atmosphere on many scientifically interesting solar bodies and favorable environmental factors in the outer solar system makes remote raman spectroscopy an attractive alternative to conventional remote sensing methods.

The primary advantages to using raman spectroscopy in remote sensing over traditional methods such as reflectance spectra and radioactive decay measurements, such as gamma-ray spectroscopy, are; the returned spectra is often less ambiguous than reflectance spectra, better resolution is obtainable with raman spectroscopy than is possible with radioactive decay measurement methods, and raman spectroscopy can study additional features of the molecules beyond simple substance composition and volumetric concentrations.

The major disadvantages of applying raman spectroscopy to remote sensing are; the returned raman spectra is very weak, advanced filter technology is required to remove the laser source signal and retain the integrity of the spectra, and the amount of surface area that can be observed by this method is limited.

## CURRENT APPLICATIONS

Raman spectroscopy is currently being used extensively in the laboratory and in some short distance atmospheric sensing applications. However, we are not aware of it being used previously in a far-remote sensing application such as is being proposed here. Laboratory raman spectroscopy is currently being used by chemists and other scientists to identify complex and compound organic substances by comparing the raman spectrum of an unknown to the spectra of known compounds. It is also used to study molecular structures, to observe chemical reactions taking place, and in the quantitative analysis of compounds.<sup>1,2</sup>

Raman spectroscopy has also been used in limited atmospheric studies and pollution control monitoring.<sup>7</sup> Atmospheric H<sub>2</sub>O has been detected to 2 km altitudes and at distances of a few hundred meters trace elements such as nitric oxide, sulfur dioxide, nitrogen, benzene, or ammonia can be detected in the range of tens of a ppm. Figure 1 schematically illustrates a remote raman system.<sup>9</sup>

Remote sensing using the raman effect has been used successfully to examine atmospheric pollutants. Figure 2 shows the type of results that can be returned. It can be seen that very small quantities of atmospheric pollutants can be detected. The spectral differences between gaseous and solid materials can be seen if Figure 2 is compared with Figure 3, which shows the raman spectrum for two materials typical of the Moon. Note how the motion of the gas causes the wide band broadening around the predicted locations and the spectrum for a solid does not exhibit this broadening. Also note that the horizontal axis for each graph is different, wavelength for the gas and wavenumber for the powders.

One reason that raman spectroscopy has not been used for remote sensing at large distances is that it is a very weak phenomena. A large power input is required, a low intensity signal is returned, and the presence of any appreciable amount of light in the region of the laser frequency, other than the laser light used to excite the sample, makes the raman effect extremely difficult to observe. An additional problem is that the light scattered back by the raman effect is readily dispersed by the earth's atmosphere. For these reasons, raman spectroscopy has been primarily a localized laboratory procedure here on Earth.

## PRINCIPLES OF RAMAN SPECTROSCOPY

Raman scattering occurs as a result of an inelastic collision of a quantum of light and a molecule of a substance. As a result of this collision, a dipole moment is temporarily induced in the molecule. The dipole moment oscillates with the frequency of oscillation dependent on the polarizability of the molecule. The polarizability of most of the molecules in the sample does not change due to the collision, and the molecules return to the same energy level that they were in before the collision took place. This is illustrated in figure 4. As a result of the dipole moment oscillations, the energy from the collision takes the form of light scattered back from the molecule in all directions. If the light is at the same frequency as the incident light, then this is known as rayleigh scattering. If the returned light is shifted in frequency, then raman scattering is said to occur. Figure 4 illustrates both raman and rayleigh scattering energy changes.

Raman scattering can be better understood by examining the energy changes that take place in the molecule. When raman scattering occurs, some of the molecules in the substance return to a different energy level than the one they were in before the collision with photons as is shown in figure 4. This net change in energy is due to a change in the polarizability of the molecule. Because of the polarizability change, the temporarily induced dipole moment can vibrate not only at the frequency of the incident light, but at frequencies above and below the incident frequency. These oscillations can be rotational, vibrational, or both.

Since the rotational and vibrational energy levels of a molecule are quantized, the scattered light is shifted by the amount of energy between the different rotational/vibrational energy levels of the molecule. The light scattered back as a result of the dipole moment oscillations can then be

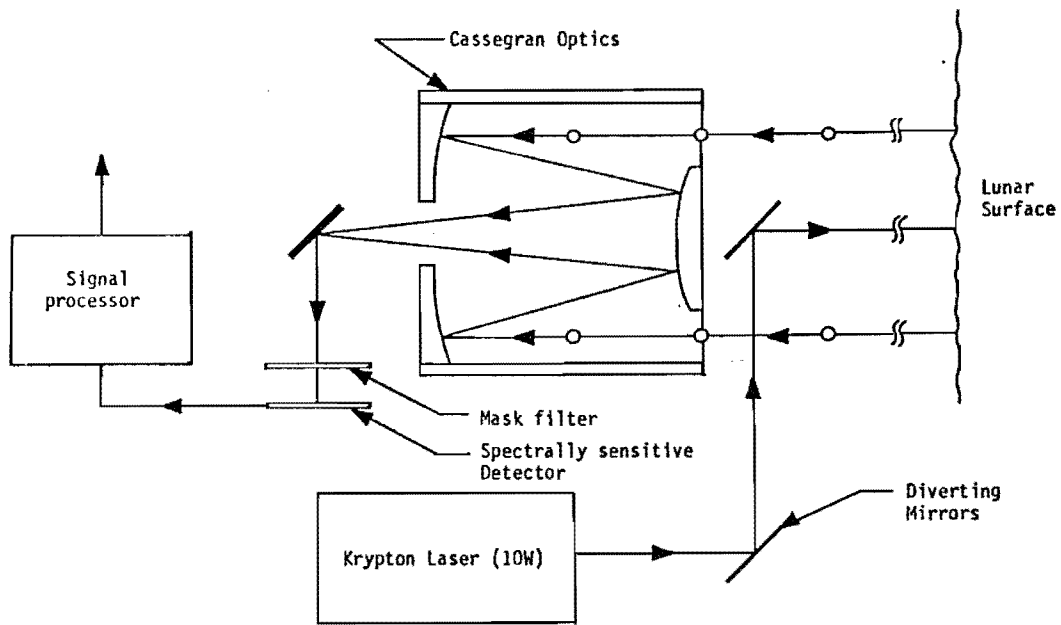

Figure 1. Schematic of remote raman instrument system.

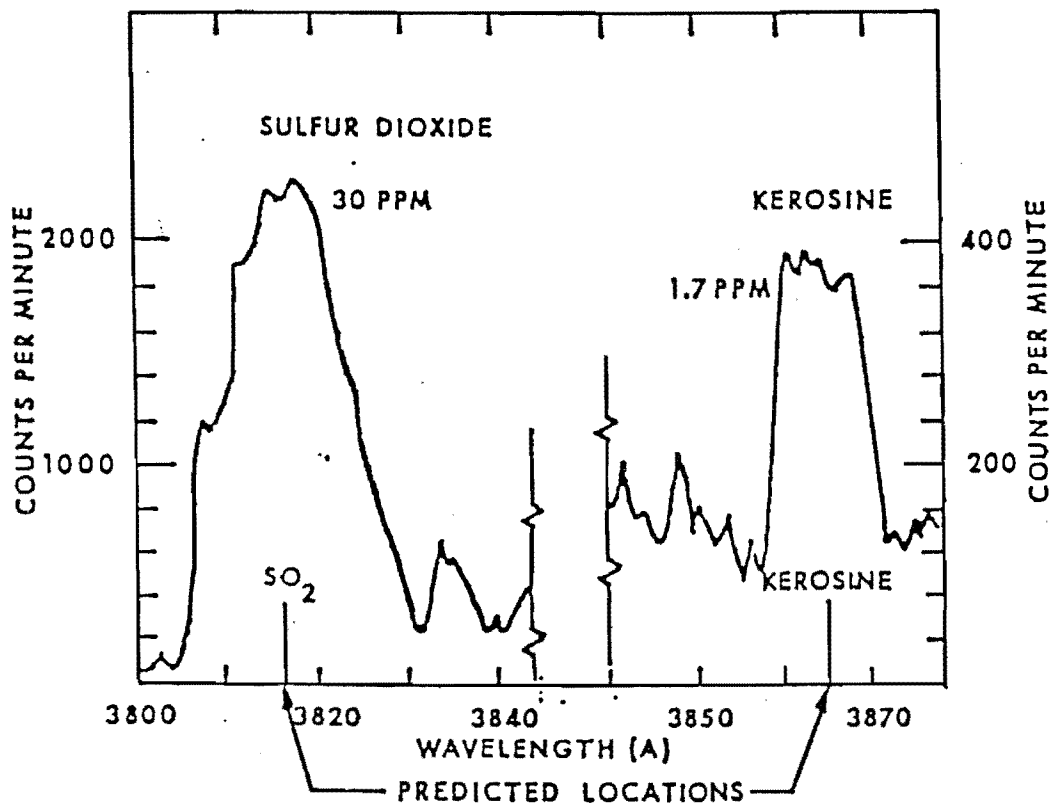

Figure 2. Raman spectra of remote sensed atmosphere pollutants<sup>9</sup>.

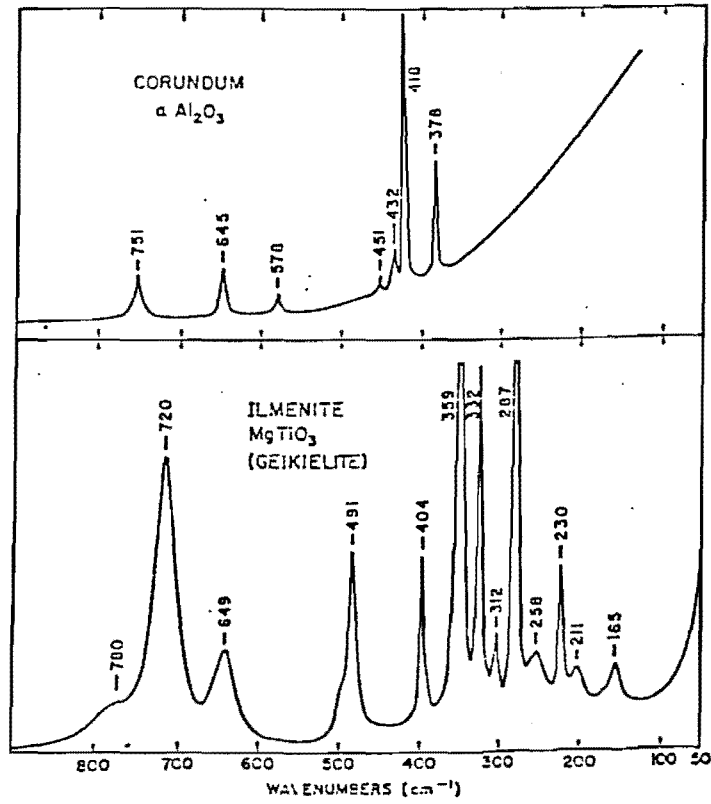

Figure 3. Raman spectra of several Apollo returned lunar samples

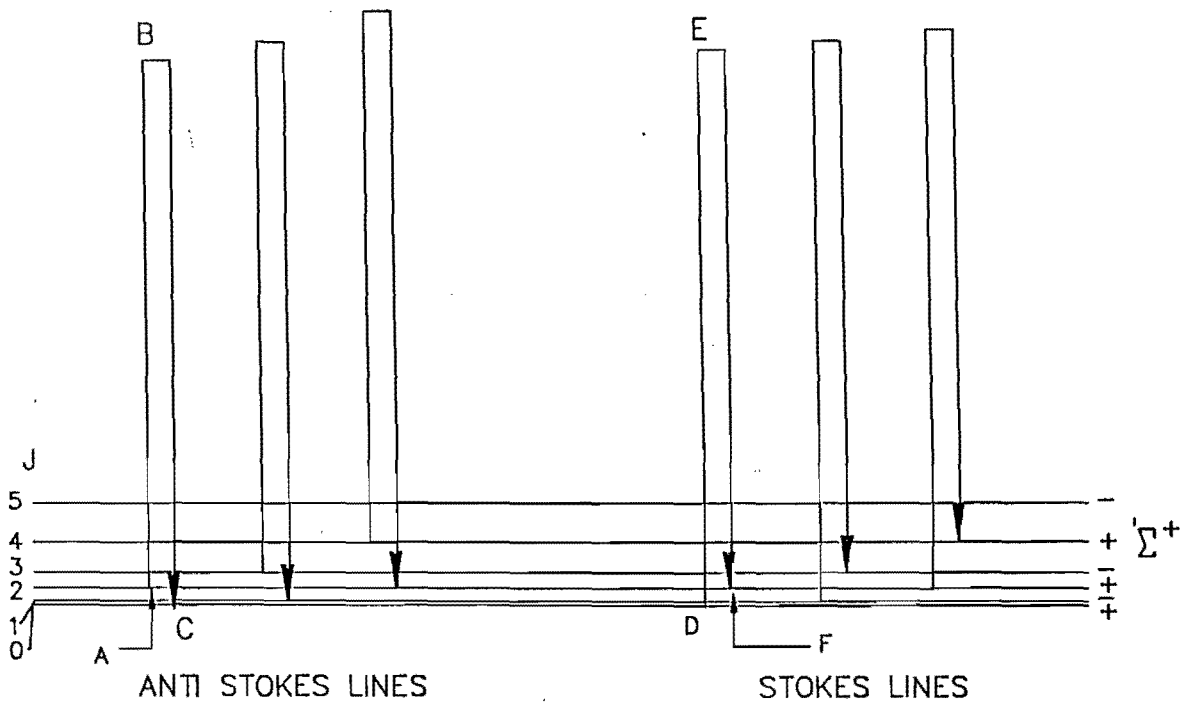

Figure 4. Energy transition diagram of the Raman effect.

of frequencies which are above or below the frequency of the incident light. This is raman scattering.

A typical laboratory raman spectrum is shown in Figure 5. The spectral lines that are at a frequency lower than the incident light frequency are called Stokes lines, and the lines are at a higher frequency are called Anti-Stokes lines. The Stokes lines and the Anti-Stokes lines are shifted the same amount on either side of the frequency of the incident light. Ideally, this would result in the Stokes lines and Anti-Stokes lines being mirror-images of each other. In practice however, the Stokes lines are usually much stronger than the Anti-Stokes lines and it is for this reason that only the Stokes lines are most often studied. The spectral lines are always displaced the same amount from the incident frequency, and can be seen as long as the incident light is not of a frequency which is absorbed by the compound, in which case very little light scattering occurs. To avoid this problem, the laser source can be used with slightly varying frequencies chosen so that no chemical species are missed because of absorption.

Raman scattering is a very weak phenomenon. Since only a fraction of the molecules in a substance undergo a net energy change, the intensity of the raman scattered light is only about  $10^{-6}$  of the incident light intensity. Because of this, a monochromatic light source, such as a laser, is necessary to avoid swamping out the raman lines.

The spacing of the spectral lines is a characteristic of the particular substance causing the raman scattering. By knowing the differences between quantized energy levels and studying the raman spectrum of a substance, it can be identified. The raman spectrum of a given sample will be a composite of all the spectra of the individual substances contained in it. Hence, by studying the raman spectrum of a planetary surface, we should be able to identify and map its mineral and chemical composition. Additionally, the composition of the upper atmospheres of planets can be studied by this method as the major and minor constituents can be identified along with their volumetric concentrations<sup>7</sup>.

The raman spectrum can also be polarized by crystals. Using optical filters on the sensor, crystals formed or ejected during meteoric impact, and the orientation of these crystals, could be detected.<sup>10</sup>

## DIFFERENCES AND SIMILARITIES TO REFLECTANCE SPECTROSCOPY

Some of the results which are expected from the remote raman spectroscopy system are similar to results expected from reflectance spectroscopy. In particular, mineral species can be identified by both methods. Some differences in the results exist, however, which make the two methods complimentary. Thus, raman spectroscopy represents a remote sensing method that is complimentary to conventional reflectance spectroscopy.

### Surface Resolution Different

The degree of surface resolution expected from each method is different. A small surface "footprint" of tens of meters wide and variable length depending on laser pulse rate is expected from the raman system at altitudes of 25 kilometers. The raman "footprint" is shown in Figure 6. Adjustable optics in the laser could facilitate changing the laser beam width and thus alter this pattern to a certain extent but the overall surface coverage will remain small. This will make it impractical or impossible to completely cover the a planetary surface with this method. Raman spectroscopy is thus better suited for high resolution site specific coverage.

### Bandwidths

The bandwidth of the individual bands in the raman spectrum is considerably narrower than bandwidths of the individual bands in a typical reflectance spectrum. With a raman spectrum, the bandwidth is proportional to the square root of the temperature of the sample. Because of this, it is possible to get a better resolution of individual mineral species at the low temperatures typical of

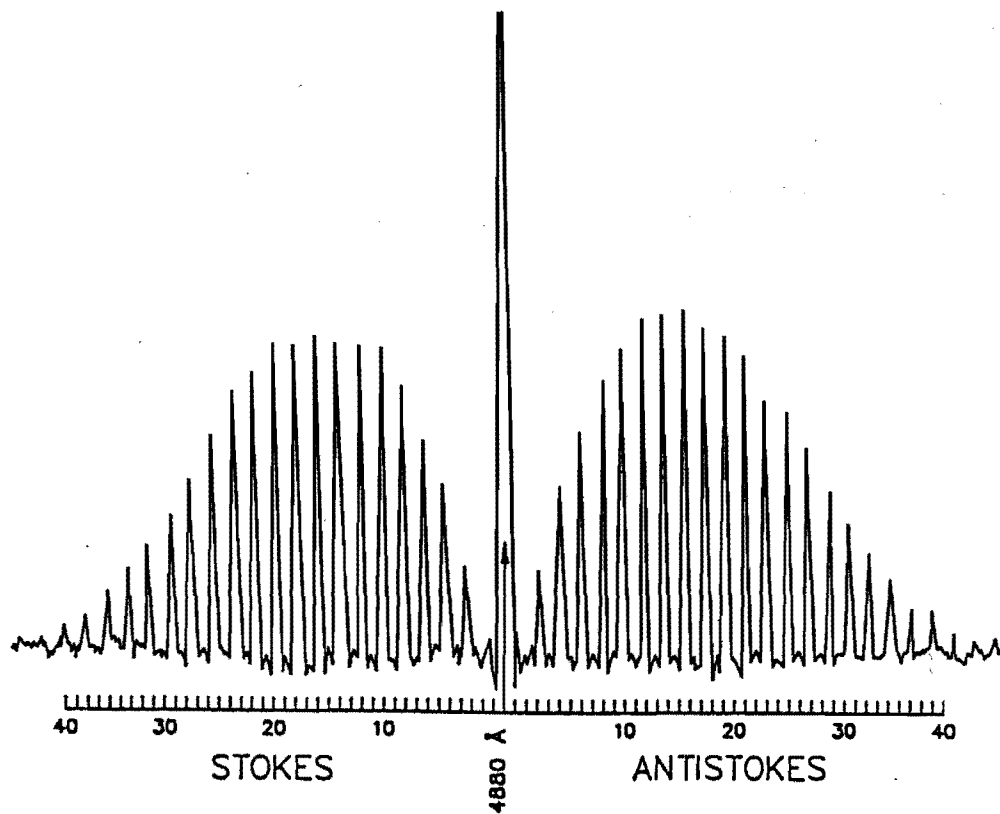

Figure 5. Raman spectrum of CO<sub>2</sub> obtained under laboratory conditions.

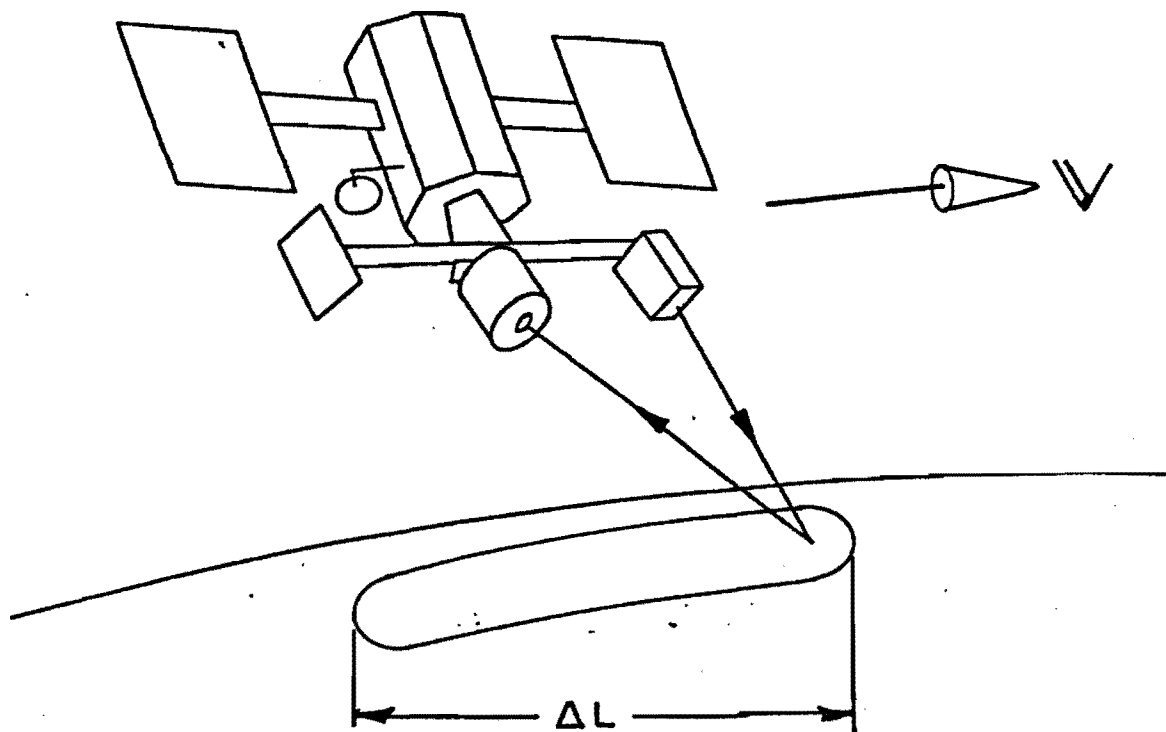

Figure 6. Footprint of laser on the planetary surface. The length of the path depends on orbital velocity and pulse length.

the outer solar system. Additionally, overtones and combination bands (second order spectra) are rarely seen with the raman effect under normal conditions. This aids in making the spectra clearer and more simplistic to analyze.<sup>10</sup>

### Spectra Different

The spectra produced by reflectance and raman spectroscopy is very different and these differences make the two methods very complimentary. Reflectance spectral bands are generally numerous and broad while raman spectral bands are generally fewer and narrower in bandwidth.

Since the spectrum of a sample will be a composite spectrum of all the minerals and chemicals which comprise it, it may be difficult to pick out the spectra of some individual minerals. With two independent spectra to study, such as raman and reflectance spectra, identification of some minerals should be easier. It is in this capacity that raman and reflectance spectroscopy are complimentary techniques. Benzene is shown in Figure 7 as an example of this. Here, the raman lines and absorption lines can be compared and the major differences noted.

### Intensity of spectral lines different

Unlike reflectance spectrum lines, the intensity of the raman spectrum lines is directly proportional to the volumetric concentration of the species present in the sample. This is because the raman spectrum is an emission spectrum, while the reflectance spectrum is an absorption spectrum. For an absorption spectrum, the presence of very small amounts of a material is sufficient to absorb all the light frequencies characteristic of that material. Conversely, for an emission spectrum, the amount of energy a substance can emit is proportional to the amount which is present. Raman spectroscopy will therefore enable a better estimate of what amounts of minerals and chemistry are present in the sample.

## RAMAN SIGNAL INTENSITY AT THE SPACECRAFT

The first consideration of the intensity of the raman scattering at the altitude of the spacecraft is that of the raman effect itself. One part per million of the incident light at the surface can be considered to be diffusely scattered by the raman effect. Absorption is assumed not to occur. This is a reasonable assumption if the laser frequency is not within the range of the absorption bands of the substance. The diffuse scattering and the raman effect itself causes the reflected spectra to vary according to:

$$[1] \quad \Phi_{\text{spacecraft}} = P_{\text{laser}} \psi / 2\pi \text{Altitude}^2$$

The amount of light scattered by the raman effect is also dependent on the polarizability of the molecule and the absolute temperature of the irradiated substance. Mathematically this may be expressed by the following:

$$[2] \quad \partial\sigma_i/\partial\Omega = (2\pi)^4 b_i^2 (\nu_0 + \Delta\nu_i)^4 g_j (i_j + 7/45 a_j^2) / (1 - \exp(-h_e \nu_i / \kappa T))$$

From this equation, it can be seen that the intensity of the raman scattering is proportional to the fourth power of the exciting frequency and is highly dependent on the temperature of the substance. Figure 8 illustrates the relationship of an exciting laser of wavelength  $\lambda$  to a laser of wavelength  $\lambda=4800\text{nm}$  (a CO laser) based on equation [2]. This ratio appears overwhelming at shorter wavelengths and thus it is evident that the frequency of the exciting laser must be considered carefully.

The ratio  $I_{\text{antistokes}}/I_{\text{stokes}}$  is a function of the raman shift frequency, the exciting frequency, and the absolute temperature of the substance. This can be expressed by:

$$[3] \quad I_{\text{antistokes}}/I_{\text{stokes}} = (\nu_0 + \Delta\nu)^4 / (\nu_0 - \Delta\nu)^4 \exp(-h\Delta\nu/\kappa T)$$

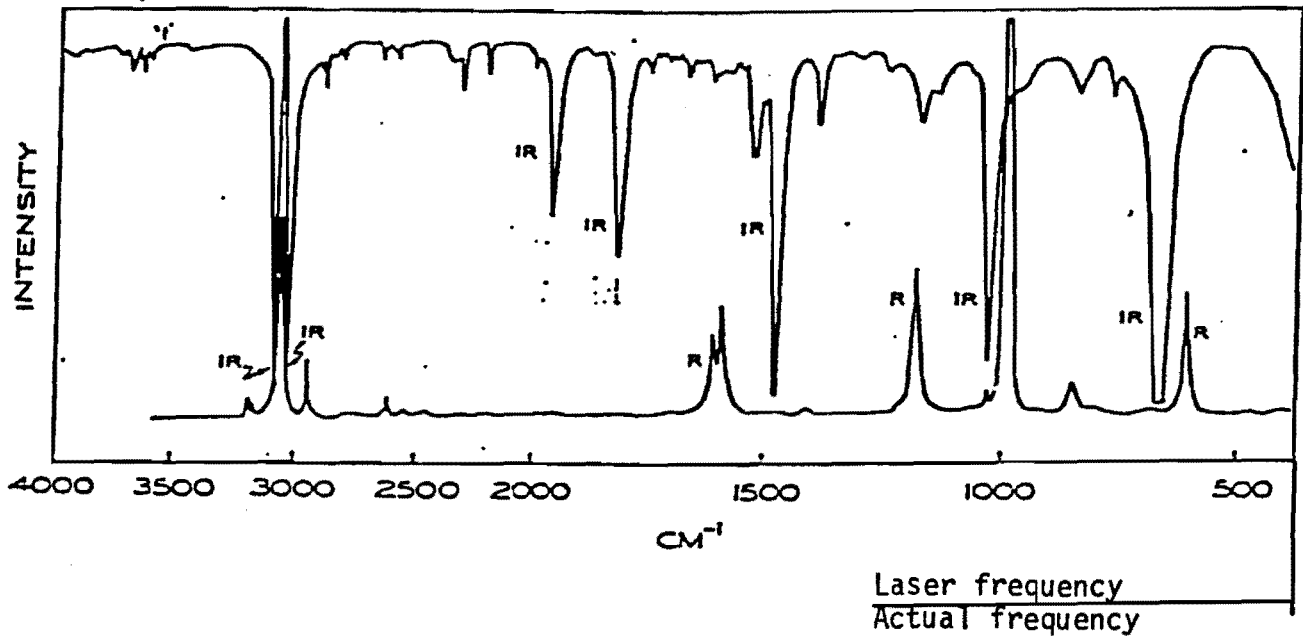

Figure 7. Reflectance and raman spectra of Benzene.

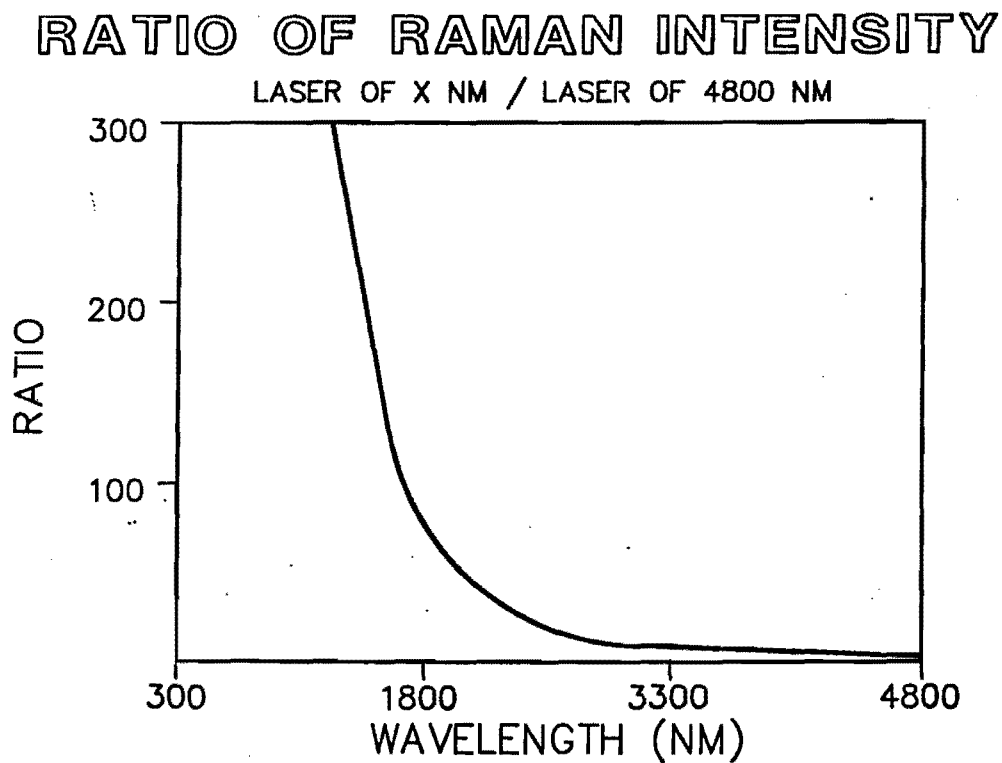

Figure 8. Ratio of raman intensity for various laser wavelength.



The effect of the temperature of the substance causes the Stokes lines to increase in intensity with decreasing temperature and the intensity of Anti-stokes lines to decrease with decreasing temperature. The denominator of the equation [3] is a result of the probability that a molecule at a given temperature will be found in a certain energy state, a Boltzmann distribution. At lower temperatures, a molecule is more likely to be found in or near the ground state and any incident radiation will likely induce a change in the molecule that will leave it in a more excited state than in a less excited state. The result is that Stokes line intensity increases and Anti-stokes line intensity decrease as temperature drops. Figures 9 and 10 illustrate how the ratio of the Anti-Stokes/Stokes lines varies with temperature and different exciting frequencies based on equation [3]. Note that a laser of shorter wavelength will cause the ratio to be more pronounced at equivalent temperatures.

## INSTRUMENT

Detectability specifications for the HIRIS spectrometer, a state of the art spectral detector array, were used in the computations. The HIRIS detector's efficiency and noise levels are expressed in terms of photon counts. If the incident radiation is expressed in terms of photon numbers, then the energy per photon must be considered from the aspect of the laser output power. Figure 11 shows the energy/photon for photons at a given wavelength. Long wavelengths are associated with low energy photons and short wavelengths are associated with high energy photons.

It is essential that the laser to be used have at least a medium power output, in the range of one watt to one hundred watts, and a very narrow, stable range of output frequencies. A high output power would be desired for two reasons. Firstly, only about  $10^{-6}$  of the incident power is raman scattered. Secondly, since light which is raman scattered is considered diffuse and radiates out in all directions, the intensity of the light received at the point of observation will vary as the inverse square of the altitude of the spacecraft as is given by equation [1].

Figure 12 shows an example of the intensity that would be observed at the spacecraft at different altitudes with different power lasers. In general, the more power used by the laser to stimulate the raman effect will increase the strength of the returned spectra. An increase in magnitude of laser power will increase the returned signal by an order of magnitude. Lowering the altitude, however, will have a much larger effect on the strength of the returned signal.

A narrow, stable range of output frequencies is needed from the laser to be able to effectively observe the raman spectrum. Ideally, the output should be of only one frequency. This exciting frequency must be such that it is not absorbed by the sample. It is not likely that there is one frequency which every possible mineral on the surface will not absorb. It is therefore proposed that the raman spectroscopy experiment be repeated several times, with different exciting light frequencies. This could be accomplished with multiple small lasers which have different output frequencies, or with a single tunable laser that has good tuning characteristics. The tunable lasers presently available have the problem of a very narrow range of tuning capability, on the order of tens of nanometers, but advances in laser technology will likely extend this tuning range.<sup>9</sup>

Lasers which are currently in use for raman spectroscopy in the laboratory are rated in the 20 milliwatt to 500 milliwatt range. NASA is currently developing a laser in the ten to one-hundred watt output power range, which is in the range required for this application.<sup>9</sup>

Many types of laser sources are available. The particular type which would be best suited to this application is an area which requires further study. Current estimates, based on earlier discussions, indicate that a Krypton laser may be most suitable. The actual choice of the laser frequency would be determined by the particular mineral or chemical species that investigators are looking for and the available laser technology.<sup>8</sup>

A laser power output of 10 Watts incident on the sample at a pulse duration of 1 second was used to develop figure 13, a plot of the photons flux at the spacecraft for varying altitudes and laser wavelengths. Using the efficiencies and noise levels projected for the HIRIS satellite, an objective

# ANTISTOKES / STOKES INTENSITY RATIO

500 NM LASER (KRYPTON ION)

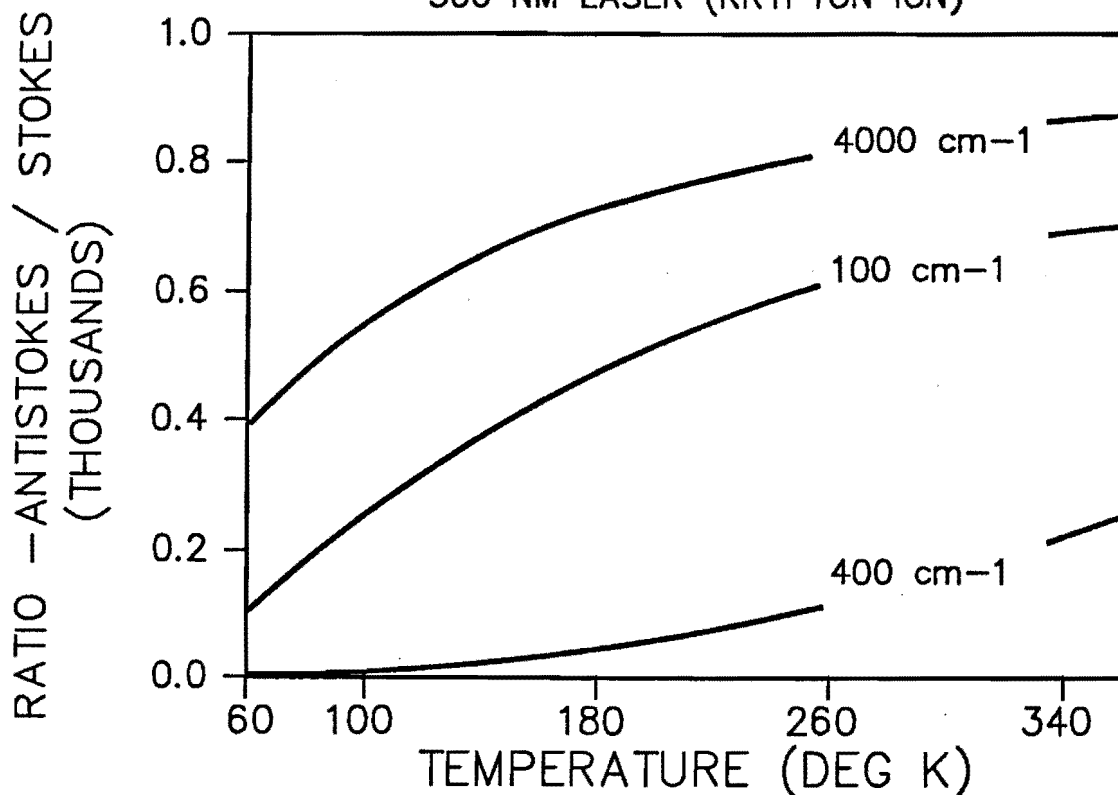

Figure 9. Ratio of stokes to antistokes intensity versus T for a Krypton laser.

# Antistokes / Stokes intensity ratio

4700 nm laser (CO)

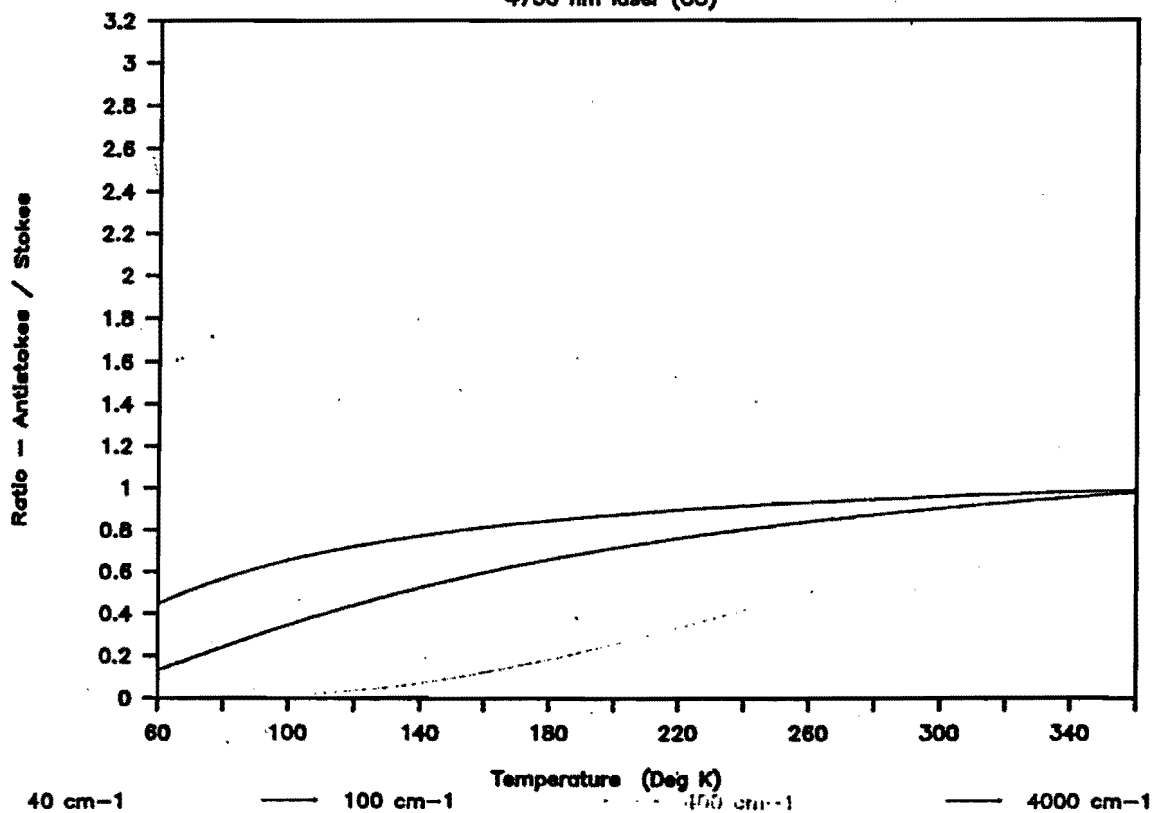

Figure 10. Ratio of Stokes/Antistokes vs. T for a CO laser.

# PHOTON ENERGY

PHOTON ENERGY VS PHOTON FREQUENCY

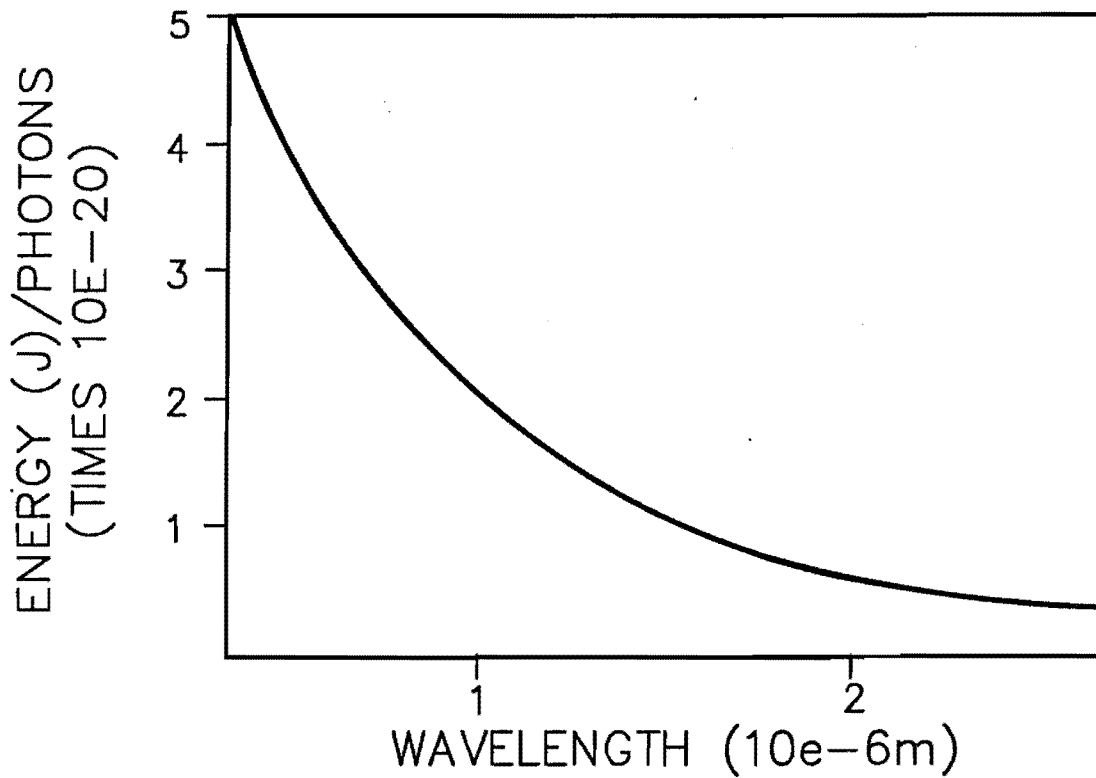

Figure 11. Photon energy versus photon wavelength.

# RAMAN SIGNAL INTENSITY

1 SEC PULSE, 10 WATT LASER (10J AT SUR)

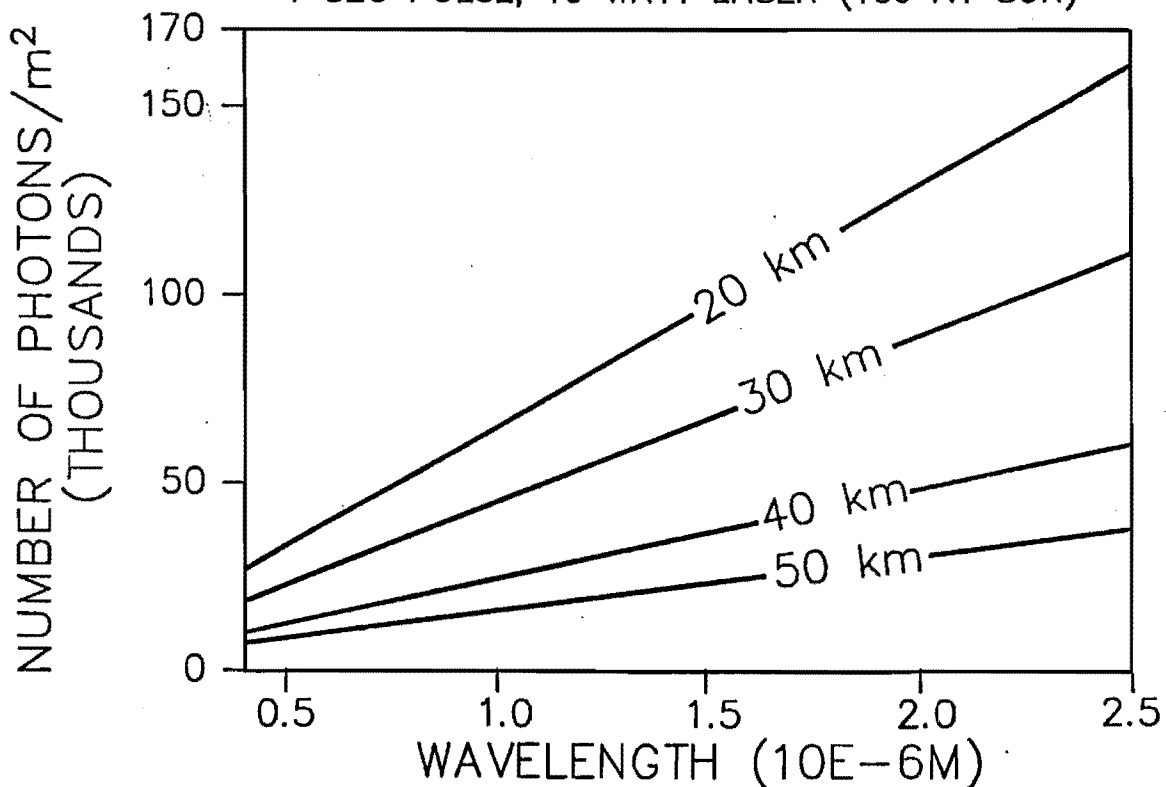

Figure 12. Photon flux vs. altitude for a 10 watt laser.

diameter of 157mm on the optics system should be sufficient to detect the raman effect at altitudes less than 40 Km. From figure 13 it can be seen that a laser of longer wavelengths will cause more photons to be received and shorter wavelength lasers cause less photons of higher average energy to be received at the spacecraft for a given altitude.

The footprint of the system will depend on the width of the laser beam on the surface and the time of the laser pulse or the sample rate of the spectrometer. Current designs show a fixed non-steerable laser and spectrometer.

A very sensitive detector must be used to observe the raman effect. A cassegran type optic system (157mm objective diameter minimum) will be used for its compactness, which is then coupled to an imaging array spectrometer, similar to sensor technology being developed for the HIRIS spacecraft.<sup>6</sup> The optics will have a narrow field of view (1 to 2 degrees : .5 to 1 km footprint), and be aimed at the same spot which the laser is aimed at in order to maximize energy return. Detailed analysis of this system was performed in reference [14].

The final estimate of the instrument package mass is around 200 Kg, which is in the payload capability of many small satellites.<sup>14</sup> Due to the inherent inefficiency of lasers, the power consumption is estimated to be approximately 1KW continuous based on a 10W laser and a 75% duty cycle.

Applications that require sampling of very small surface areas can make possible use of higher power pulsed lasers. This would return a stronger raman spectrum which would dramatically increase the possibility of detecting very minute substances. The factors that would limit pulsed lasers are the size and weight as well as the pulse duration time and laser circuit recharge time.

Advantages found in interferometers or fourier analysis systems can be used to allow use of multiple excitation frequencies.<sup>13</sup> The use of a pulsed or continuous beam laser would depend on specific mission objectives. A pulsed laser would allow the best spectrum possible to be gathered while a continuous laser would give a more thorough coverage of the surface.

## MISSION TO THE MOON

The moon is a scientifically interesting body which is rich in information concerning the origin of the solar system. Additionally, the moon has acted as a permanent record for solar activity during the last several million years. But perhaps the greatest promise of the moon is its resource potential. The moon is known to be abundant in oxygen and various metals, all of which can find ample use in man's future deep space activities. Hence, the exploration of the moon for exploitables, or prospecting it, is an important next step in unlocking its total resource potential and a remote raman system could be used to locate these resources.

The raman mission to the moon with a small satellite was studied in depth in reference [14]. The mission was designed as to take advantage of the differences and similarities in other expected lunar surface studies. The mission utilizes a reflectance spectrometer to obtain a complete characterization of the lunar surface. From this preliminary map, specific areas of geologic interest on the surface can be identified for more detailed study. The raman sensing package can then be used to obtain confirmation of the reflectance results, with better surface resolution, and to obtain a better estimate of the amounts of minerals present. These complementary results will make possible a better, more accurate map of the lunar surface than would be possible with either method alone. The raman spectroscopy package is baselined to operate from an elliptical orbit with a low periapsis of around 25 km. For purposes of weight limits and power needs the system that has been considered was one of a nadir pointing, non-movable system. If the package is given pointing capabilities then a better study of the polarization that produces raman spectra would yield even more precise data on mineral composition, possible crystal orientation, and mineral quantities.

As mentioned above, the raman effect is easily swamped out by any appreciable light at frequencies other than the exciting frequency of the laser. The raman spectroscopy study of the

# Raman Signal Intensity

Intensity with 1s pulse at surface

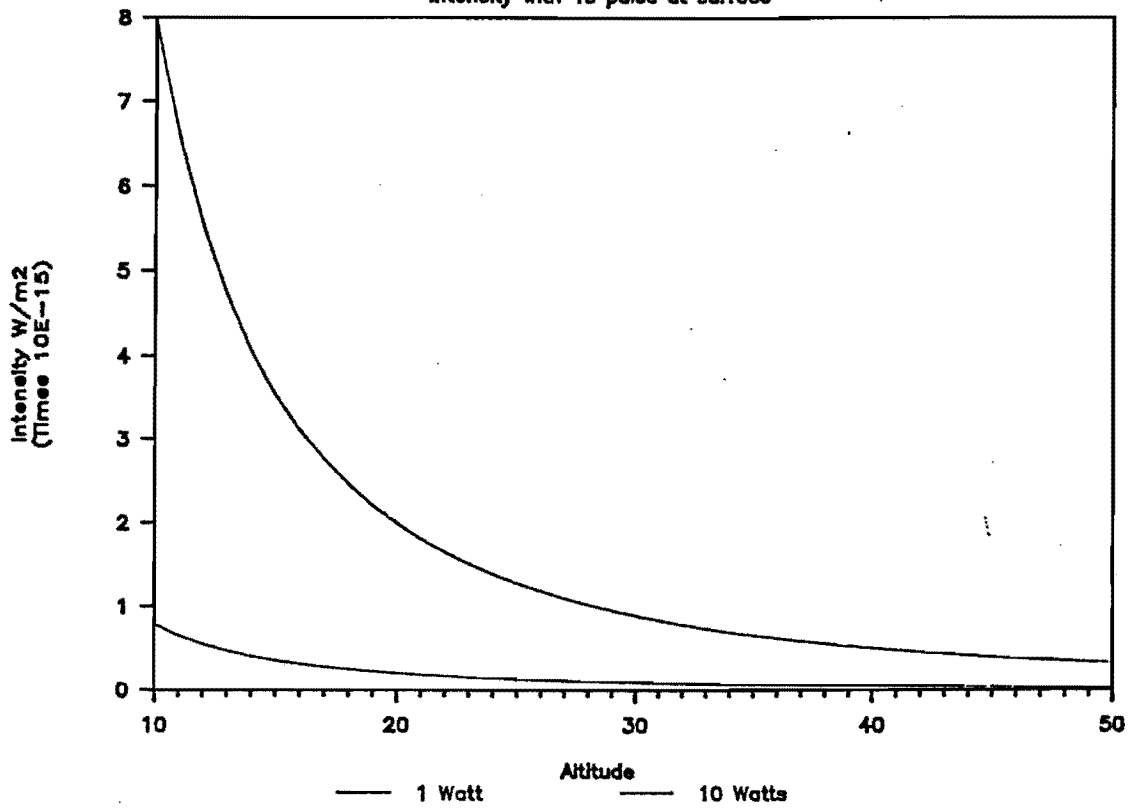

Figure 13. Raman signal intensity vs. altitude for a 10 watt and a 1 watt laser.

lunar surface will be done on dark side of Moon while the space craft is in the Moon's shadow or with the raman spectrometer shielded from the sun since the Krypton laser's output is in the visible range. Since there is no atmosphere on the moon to disperse the raman scattered light, the raman effect can be observed at large distances without interference.

## **OTHER SOLAR SYSTEM MISSIONS**

Using a raman spectroscopy package to study the composition of solar bodies need not be limited to the moon. Other planets and asteroids in the solar system are equally scientifically interesting and the study of them with raman spectroscopy could yield vast new information.

Bodies in the Solar System that are much the same in nature as the moon could be studied for similar information. Mercury and the Jovian satellites are examples of such bodies that have no cloaking atmosphere to hide the surface. Studies of the surface composition of these bodies would yield information about the formation of the solar system and subsequent events that have brought changes to them.

The use of raman spectroscopy could also be extended to our own planet Earth. With the recent concern of our changing the Earth's climate, difficult to study components of the atmosphere may prove to be detectable from low orbiting spacecraft that examine the atmospheric limbs using laser stimulated raman spectroscopy. Studies of pollution circulation in the stratosphere and the ozone layer could be monitored with an orbiting raman package. Additional phenomena such as the aurora might also be studied by raman spectroscopy which might lead to a better understanding of this phenomena.

The atmospheres and ring systems of the outer planets can be studied with a small raman package. The atmospheres of the gas planets could be studied for minor constituents. Perhaps the most intriguing would be the study of the composition, particle sizes and temperatures of Saturn's rings. Since the raman effect is a polarization phenomenon, effects of magnetic fields on ionized particles could be studied such as the proposed magnetic fields that generated the spoked effect on Saturn's rings which the Voyager spacecraft viewed.

Of particular interest might be the study of the Martian atmosphere from space. Using raman spectroscopy it would be possible to monitor the movement of gases in the atmosphere and allow us to model the circulation of minor constituents in the atmosphere.

## **CONCLUSION**

The use of remote raman spectroscopy to explore the solar system represents a remote sensing method that is an alternative to conventional sensing and is also complimentary to them. The basic remote raman method is made possible by applying familiar raman laboratory techniques and available laser and sensor technology to a remote sensing instrument. Initial design results indicate that the package is of a reasonable mass that is compatible with the new generation of small satellites. The package is also simple in design as it requires no active sensor cooling. Raman spectroscopy, although not really new, has yet to be applied to studying the solar system in general and this may become a very valuable tool to exploring the worlds around us.

## REFERENCES

1. **Spectroscopy Vol. 2;** ed. by B.P. Straughan and S. Walker, Chapman and Hall, 1976.
2. **Introduction to Infrared and Raman Spectroscopy;** (second edition) Colthrup, Daly, and Wiberly, Academic Press, 1975.
3. **Optical and Laser Remote Sensing;** ed. by D.K. Killinger, A. Moorgdian, (Springer series in Optical Sciences, #39), Springer-Verlag 1983.
4. **Tunable Solid State Lasers for Remote Sensing;** ed. by Byer, Gustafsen, and Trebino, (Springer series in Optical Sciences,#51) Springer-Verlag 1984.
5. **Scientific and Engineering Applications of Commercial Laser Devices;** Proceedings of the International Society for Optical Engineering, vol. 610, ed. by R. Feinberg, L. Holmes, M. Levitt, 1986.
6. **Earth Observing System Reports, vol. IIC, HIRIS;** NASA Publications, 1987.
7. **Laser Monitoring of the Atmosphere;** ed. by E.D. Hinckley, (Topics in Applied Physics, Series by Springer-Verlag) #14, 1978.
8. **Handbook of Space Technology: Status and Projections;** R. Michael Hord, CRC Press, 1984.
9. **Applications of Laser Raman Spectroscopy;** Stanley K. Freeman, Wiley-Interscience, 1974.
10. **Infrared and Raman Spectroscopy of Lunar and Terrestrial Minerals;** Clarence Karr, Jr., Academic Press, 1975.
11. **Introduction to the Theory of Molecular Vibrations and Vibrational Spectroscopy;** L. A. Woodward, Oxford University Press, 1972.
12. **Laser and Coherence Spectroscopy;** ed by Jeffery I. Steinfeld, Plenum Press, 1978.
13. **FT-Laser Raman Spectroscopy Leaps Forward;** Laser Focus/Electro optics, May, 1988.
14. **Lunar Orbiting Prospector, Utah State University, Final Design Report to USRA/NASA, 1988.**

## NOTATION

$a_j$	= anisotropic portion of polarizability tensor
$b_j$	= zero point vibrational amplitude of $j$ th vibrational mode
$g_i$	= degeneracy of $i$ th vibrational mode
$h$	= Planck's constant
$i_i$	= isotropic portion of the $i$ th polarizability tensor
$I$	= intensity of returned raman spectra
$P$	= power
$T$	= absolute temperature of the substance
$\kappa$	= Boltzmann constant
$\nu_i$	= scattered frequency
$\nu_o$	= incident laser frequency
$\Delta\nu$	= raman frequency shift
$\partial\sigma_i/\partial\Omega$	= differential backscattering cross section
$\Phi$	= energy flux
$\psi$	= raman emission coefficient ( $\approx 10^{-6}$ )