

Pegasus Air-Launched Space Booster

by

Robert E. Lindberg* and Marty R. Mosier**
Orbital Sciences Corporation

ABSTRACT

The Pegasustm Air-Launched Space Booster development program, begun in early 1987, has the objective of combining an innovative approach to satellite launch operations with the latest in proven launch vehicle technology. Air launch of small satellite payloads on Pegasus provides a substantial performance improvement over ground-launched systems and also offers new launch operations flexibility including the ability to launch directly into virtually any orbital inclination. This paper describes the overall Pegasus vehicle design and reviews those design aspects that influence the design and integration of satellite payloads.

Introduction

The Pegasus Air-Launched Space Booster is a new launch vehicle being developed in a privately funded joint venture by Orbital Sciences Corporation and Hercules Aerospace Company. Pegasus is a three-stage, solid-propellant, inertially-guided, all-composite, winged vehicle. The vehicle is 50 feet long, 50 inches in diameter, and has a gross weight of approximately 41,000 lb. It is carried aloft by a conventional transport/ bomber-class aircraft to level-flight launch conditions of approximately 44,000 feet altitude and high subsonic velocity. After release from the aircraft and ignition of its first stage motor, Pegasus follows a nearly vacuum-optimal lifting-ascent trajectory to orbit. The vehicle is capable of carrying a 600 pound payload to a 250 nautical mile circular polar orbit as well as larger payloads to lower altitude/lower inclination orbits. The winged vehicle can also deliver research payloads of over 1000 lb. on ballistic and depressed suborbital trajectories.

The Pegasus air-launch approach will provide for the first time a highly flexible launch system capable of distributed remote basing, rapid launch processing, reduced ground support, improved range safety and enhanced launch system survivability.

The 28-month development program was begun in early 1987, and the Pegasus vehicle will be available for launch services to both government and commercial users beginning in the summer of 1989.

* Director of Advanced Projects, Associate Fellow AIAA
** Senior Systems Engineer, Member AIAA

This paper describes the system design and vehicle performance of the Pegasus Air-Launched Space Booster.

System Description

The Pegasus vehicle combines modern propulsion, structural and avionics technologies with an air-launched, lifting-ascent trajectory, to achieve approximately twice the payload fraction of other small launch vehicles. This substantial payload performance increase over an identical ground-launched booster results from a combination of factors: reduced drag due to a lower air density flight profile, improved propulsion efficiency due to higher optimum motor expansion ratios, reduced gravity losses that result from a lower average flight path angle due to the unique shallow "S-shaped" trajectory, wing-generated lift, and reduced thrust direction losses due to lower velocity turning requirements. These factors are all in addition to the kinetic and potential energy imparted by the aircraft which by itself provides a 10-15% payload improvement.

Pegasus offers significant operational advantages over traditional pad-launched rockets. For example, air-launching can significantly reduce range safety problems, particularly during the first several minutes of flight when a conventional launch vehicle is normally near land and close to inhabited areas. Air launch also increases the range of orbital inclinations achievable without energy-wasting "dog legs" or out-of-plane maneuvering by expanding the range of safe launch azimuths. While the development flights will be conducted over and tracked by Western Test Range facilities, Pegasus and its tracking and other support equipment have been designed to operate independently from ground launch facilities.

Flight Vehicle

The Pegasus flight vehicle is shown in Figure 1. The vehicle consists of three graphite composite case solid-propellant rocket motors, a fixed high mounted composite delta wing, an aft skirt assembly including three composite fins, an avionics section atop the third stage, and a two-piece composite payload fairing.

Pegasus main propulsion uses three new graphite-epoxy composite case solid-propellant rocket motors that are being developed by Hercules Aerospace Company. The motors are being developed using a conservative design philosophy that includes the use of demonstrated component technology throughout, maximum use of common components and tooling among stages, and a conservative 1.4 factor of safety. All three motors use IM7 graphite composite cases with aramid filled EPDM rubber internal insulator, cork external insulator and integral skirts. Each nozzle consists of carbon phenolic exit cone with 3-D carbon-carbon integral throat/entry (ITE). The propellant grains employ class 1.3 propellants and are designed for low burn rates. The solid-

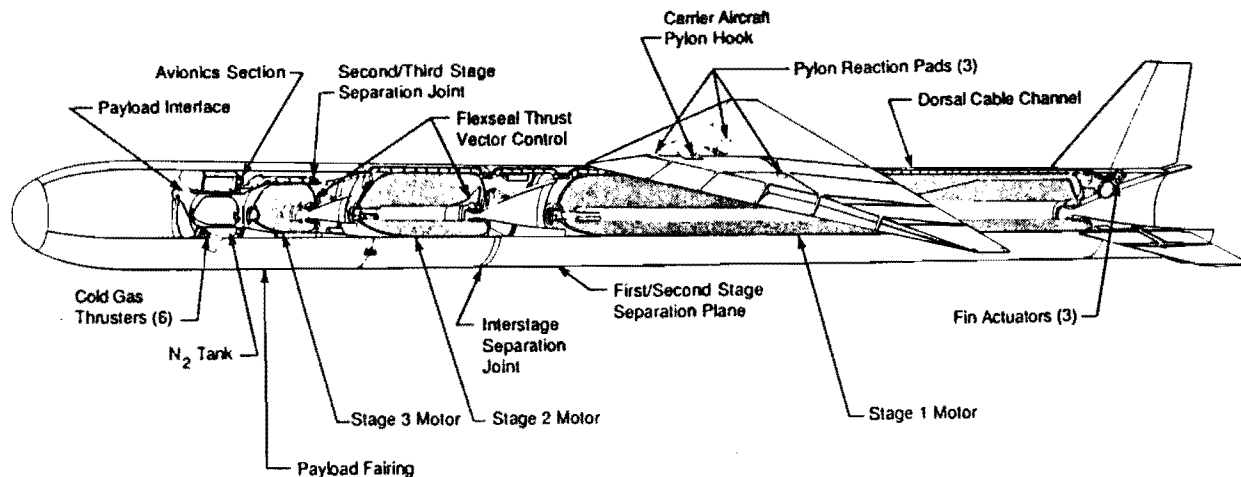

Figure 1 Pegasus Cutaway Drawing

propellant rocket motors are being manufactured using the most recent improvements in propellants, cases, insulators, nozzles and automated manufacturing processes.

The first stage motor has a core-burning grain design. The design includes a fixed nozzle, an aluminum wing saddle, and an extended forward skirt. The wing saddle is wound-in to the motor case during case fabrication. The forward skirt, which also serves as an interstage adapter, incorporates a linear shaped-charge just forward of the motor dome for stage separation. The second stage motor is also a core burning design and uses a silicon elastomer flexseal nozzle and electromechanical thrust vector actuator (TVA) for thrust vector control. The third stage motor incorporates a head-end grain design to maximize propellant density. The third stage also uses a flexseal nozzle and electromechanical TVA, and employs an aft-mounted toroidal igniter.

The flight termination system is designed to satisfy both range safety and aircraft safety requirements. When initiated, the termination charge is designed and located to cut several layers of the graphite case which compromises case structural integrity. If the case is pressurized (i.e., the stage is ignited), the case will rupture locally and the stage will immediately become nonpropulsive and begin to tumble. The flight termination system can be initiated remotely by range safety and is automatically initiated in the event of premature stage separation. All flight termination ordnance is protected by mechanical safed and electrically armed safe and arm devices which are interlocked in the safe position prior to release from the carrier aircraft.

The wing is a truncated delta platform with a 45° sweepback leading edge and a 264 inch wing span. The airfoil is a 10% double wedge with a 1 in radius leading edge. The wing thickness is truncated to 8 in., with upper and lower parallel surfaces

facilitating attachment to the ASE pylon adapter and motor case wing saddle respectively. The wing and fins are fabricated of lightweight graphite composite material and are foam filled.

A two-piece aluminum aft structure support three active fins, associated fin actuators and control electronics. The avionics structure is an aluminum built-up assembly that includes a conical section, a cylindrical section and a planar honeycomb deck. The assembly serves as the mounting structure for most vehicle avionics, including an inertial measurement unit (IMU), flight computer, telemetry transmitter, telemetry multiplexer, ordnance and thruster driver units, dual flight termination receivers, radar transponder, and batteries. The structure also provides a mechanical interface for the payload. The payload fairing is a pyrotechnically actuated two-piece graphite composite structure that has the same 50 inch outside diameter as the motor and encloses the payload, avionics assembly and third stage motor. The design provides openings for the two pods of RCS thrusters so that reaction control is available about all three axes prior to payload fairing separation.

Guidance, Navigation and Control

Pegasus has an advanced avionics architecture that takes full advantage of progress in microelectronics technology during the past 15 years. The vehicle functional block diagram is shown in Figure 2. The vehicle autopilot, which runs on the vehicle's 68020-based flight computer, combines guidance, navigation and control (GN&C) functions, as well as a mission event sequencer, to guide the vehicle to its final orbit. The autopilot is driven by a mission data load which is developed for each mission and loaded into flight computer non-volatile memory (EEPROM) on the ground or once airborne prior to vehicle release. The autopilot processor obtains inertial position and attitude from the Inertial Measurement Unit (IMU) and commands the various vehicle control actuators via standard RS-422 serial lines. GN&C performance is monitored by the autopilot processor and real time performance data is downlinked via the flight telemetry system.

Telemetry

The vehicle is heavily instrumented to provide real time telemetry for all mission critical events, stress levels and temperatures. Remote telemetry multiplexer units are located on Stage 1, Stage 2 and on the avionics deck. These microprocessor based multiplexer units contain all signal conditioning and analog-to-digital converters necessary to monitor temperature, strain and status points on each stage and convert this information to a digital RS-422 serial data stream. The flight computer monitors the remote multiplexers as well as vehicle GN&C status information from the IMU. Telemetry information is combined and formatted into a range compatible IRIG telemetry stream which is transmitted to

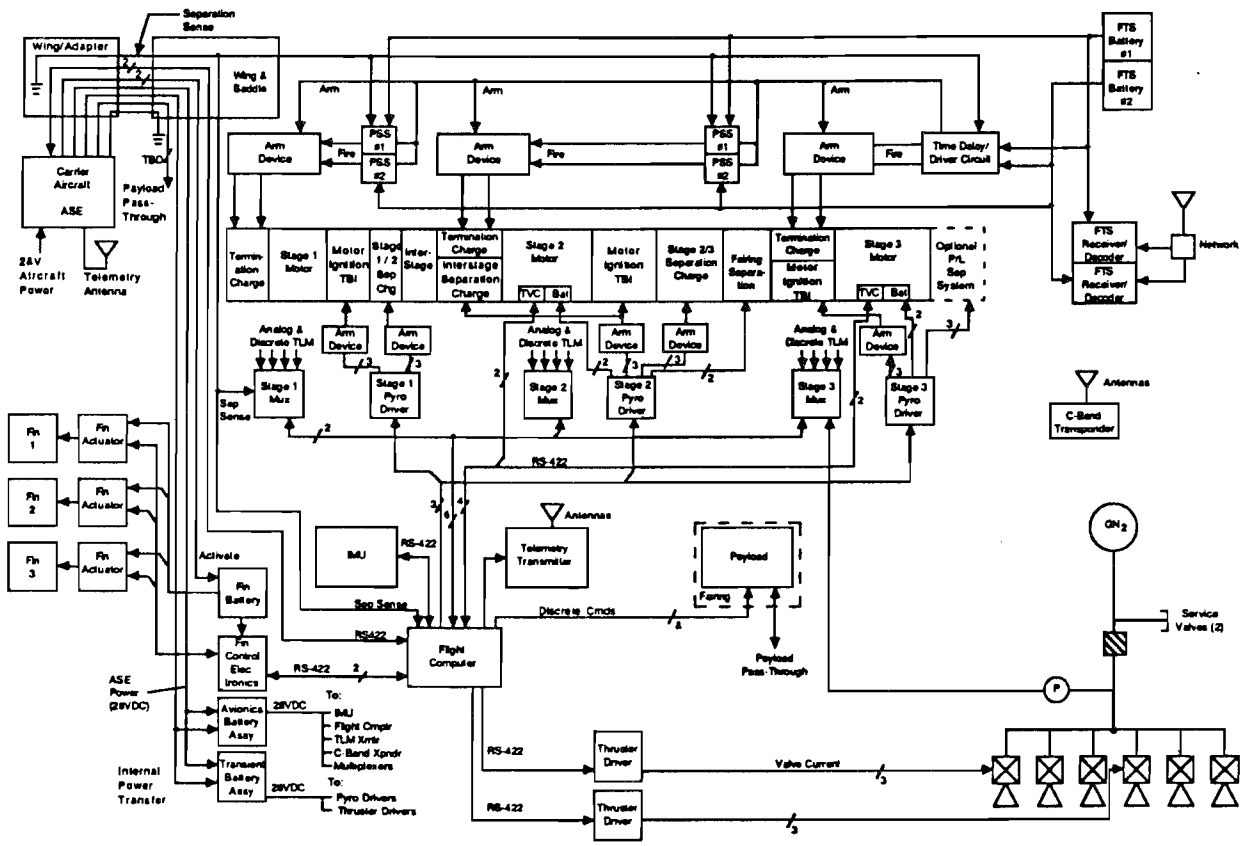

Figure 2 Pegasus Functional Block Diagram

the ground via a single 56 kbps S-band telemetry channel. A C-band radar transponder is also provided to enhance vehicle radar return.

Airborne Support Equipment

The major components of airborne support equipment, located on the carrier aircraft, include a launch panel operator (LPO) console electronic pallet and a pylon adaptor. The LPO console consists of a ruggedized computer, display device, precision inertial measurement unit, mass data storage device, uninterruptable power supply and telemetry receiver. The LPO console allows a crew member to monitor vehicle status, provide conditioned external power, update vehicle IMU prior to release, download and verify the mission data load and monitor S-band telemetry. The pylon adaptor is a steel structure that interfaces Pegasus with the carrier aircraft. During the development phase, launch operations will be conducted using the NASA B-52- 0008. This aircraft has a wing mounted pylon specifically designed to support the X-15. For the development program a pylon adaptor has been designed to adapt this pylon to the Pegasus vehicle. Alternative launch platforms have been identified to support future operational launches and custom mounting adaptors will be developed to support new carrier aircraft when required.

Ground Support Equipment

Ground support equipment includes a multifunction Assembly and Integration Trailer (AIT), custom shipping & build-up dollies, small portable cranes, assembly fixtures, electronic test equipment, and a portable clean room for payload environmental control. Final vehicle integration occurs in the horizontal position on the AIT. Once the vehicle has been integrated and tested, the AIT is used to transport the vehicle to the carrier aircraft, elevate it, and align it for mating with the carrier aircraft. The AIT is also used for de-mating, safing and disassembly, if required. The AIT provides full six-degree of freedom movement capability and is pulled by a standard aircraft towing tug. The AIT has a diesel electric generator and air conditioning unit which supplies power for ramp operation and filtered conditioned air for the payload.

Launch Operations

The sequence of events for a typical launch profile are summarized in Figure 3. The time, altitude, velocity and flight path angle for the motor ignition, separation and burnout events are typical for a trajectory that achieves a 250n.mi. altitude circular polar (90° inclination) orbit.

The launch sequence begins with release of the Pegasus launch vehicle from the carrier aircraft at 44,000 ft altitude and 0.80 Mach. After clearing the aircraft, first stage ignition occurs approximately 300 ft below aircraft altitude. The vehicle quickly accelerates to supersonic speed before beginning a pull-up which is nominally limited to 2.5g transverse acceleration. Maximum dynamic pressure occurs at approximately 30 sec after launch. At approximately 35 sec, a maneuver is initiated to depress the trajectory, and the vehicle angle of attack quickly approaches zero. Attitude control during first stage burn is provided by the three active aerodynamic fins.

Second stage ignition occurs shortly after first stage burnout and the payload fairing is separated during second stage burn at an altitude sufficient to assure that the payload does not experience excessive pressure or heating rate. Second stage burnout is followed by a long coast, during which the satellite and third stage nearly achieve orbital altitude. The third stage motor provides the necessary impulse to circularize the orbit. Third stage burnout typically occurs 10 minutes after launch and approximately 1200 n.mi. downrange from the launch point. Attitude control during second and third stage powered flight is provided by the thrust vector control system (pitch and yaw) and the cold gas nitrogen Reaction Control System (RCS) (roll). The RCS provides three-axis control during coast phases.

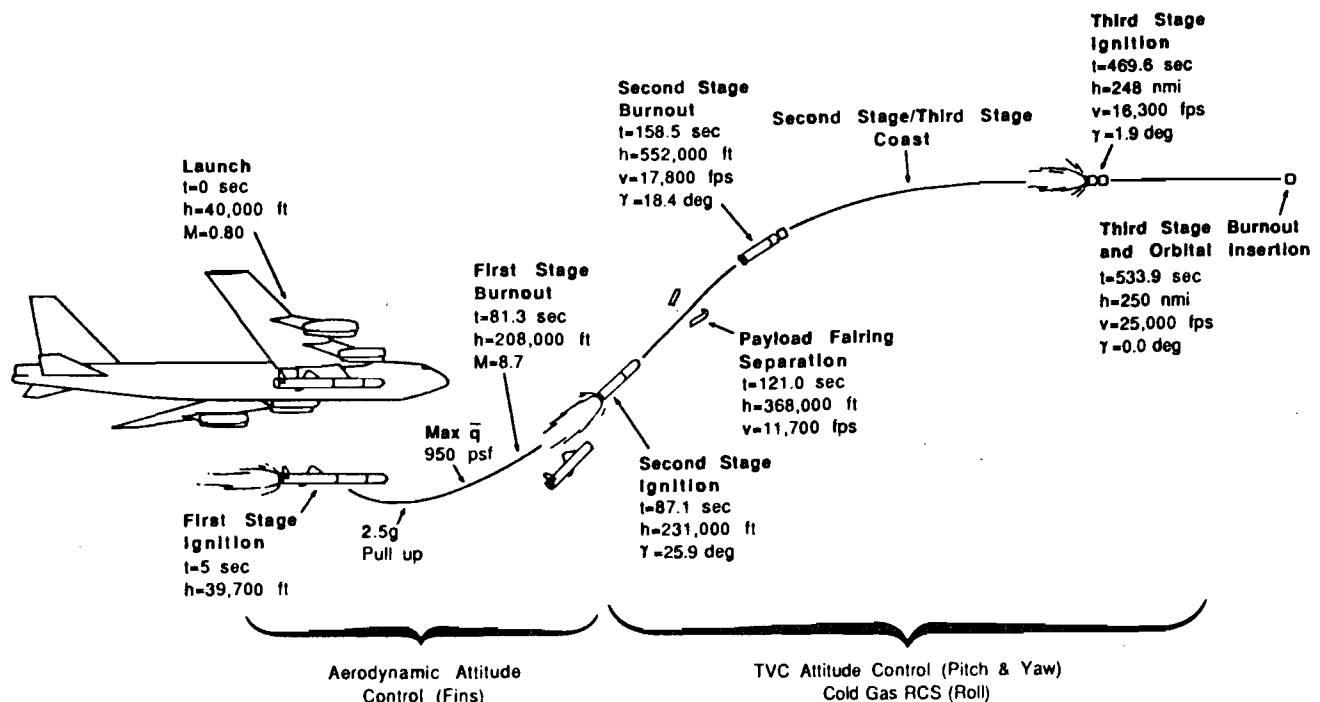

Figure 3 Pegasus Baseline Mission Profile

Payload Performance

Payload performance capability for Pegasus is summarized in Figure 4. The polar performance (solid lines) assumes the baseline launch latitude of 36° , and the equatorial performance (dashed lines) assumes an equatorial launch latitude (0°). Pegasus can achieve a complete range of circular and elliptical orbits, both prograde and retrograde through a suitable choice of launch point and launch azimuth. Orbital inclinations from 55° through 110° or better can be obtained from launch points within control of WSMC, inclinations from 20° to 60° or better can be achieved from overwater launch points within control of ESMC. Special arrangements can be made to launch into very low inclinations (0° to 20°) from overwater launch points at low latitudes. Pegasus can also place non-satellite payloads (attached or deployed) into a wide range of ballistic and depressed suborbital trajectories. For such missions, payloads can be as much as 1500 lb. or more.

Payload Interfaces

The available payload volume and standard mechanical interface are shown in Figure 5. The volume represents the maximum dynamic envelope allowed for the payload during captive carry and flight. The location of the combined payload and adaptor center of mass is restricted to satisfy bending and buckling load limits of the avionics structure design. The maximum axial displacement of the combined payload and payload adaptor center of mass, relative to the payload interface plane is summarized in Figure 6. The standard payload mechanical interface consists of a bolt hole pattern in the aluminum honeycomb deck, reinforced by doublers on

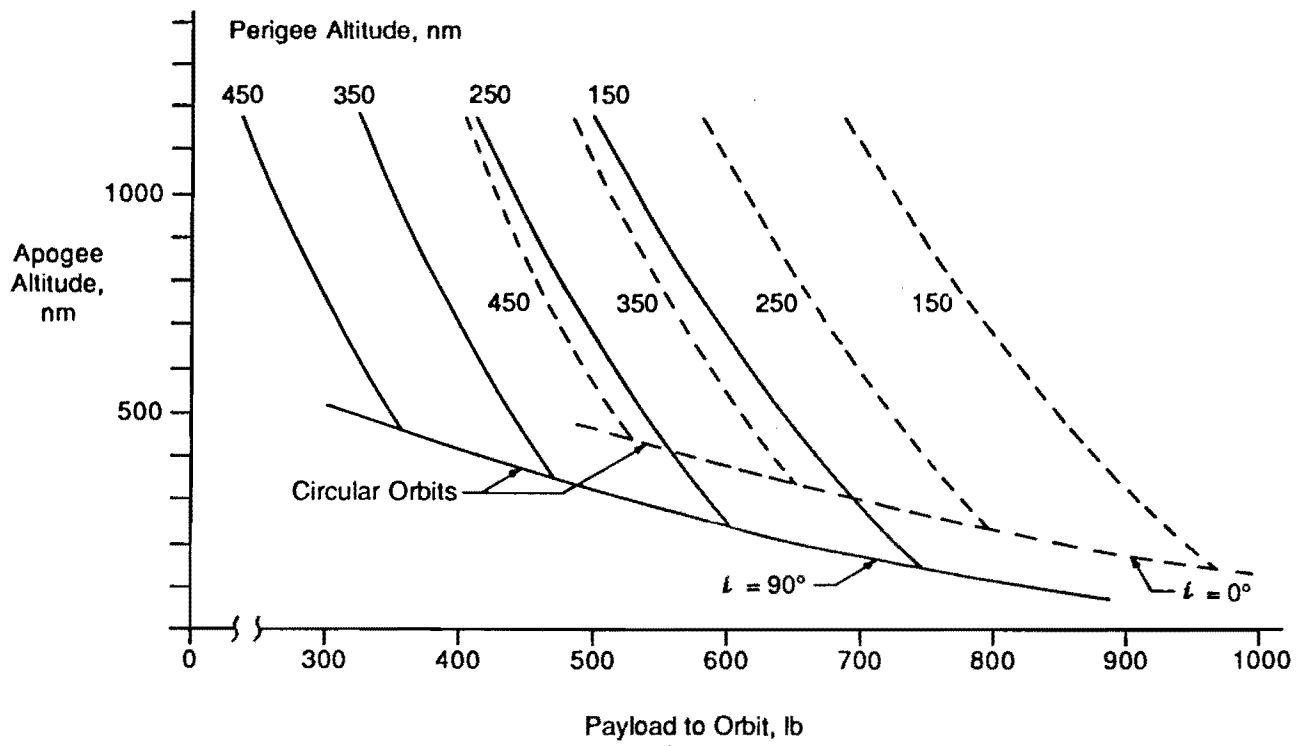

Figure 4 Pegasus Payload Performance

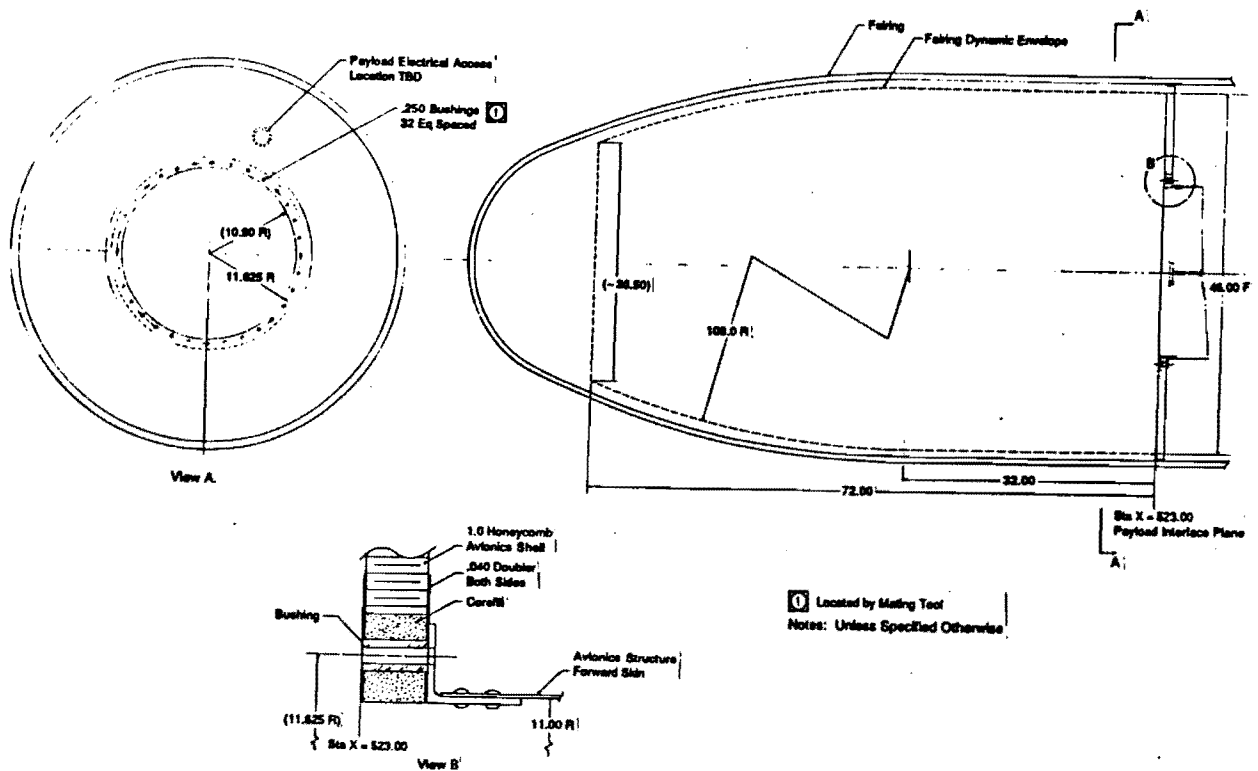

Figure 5 Pegasus Payload Volume and Mechanical Interfaces

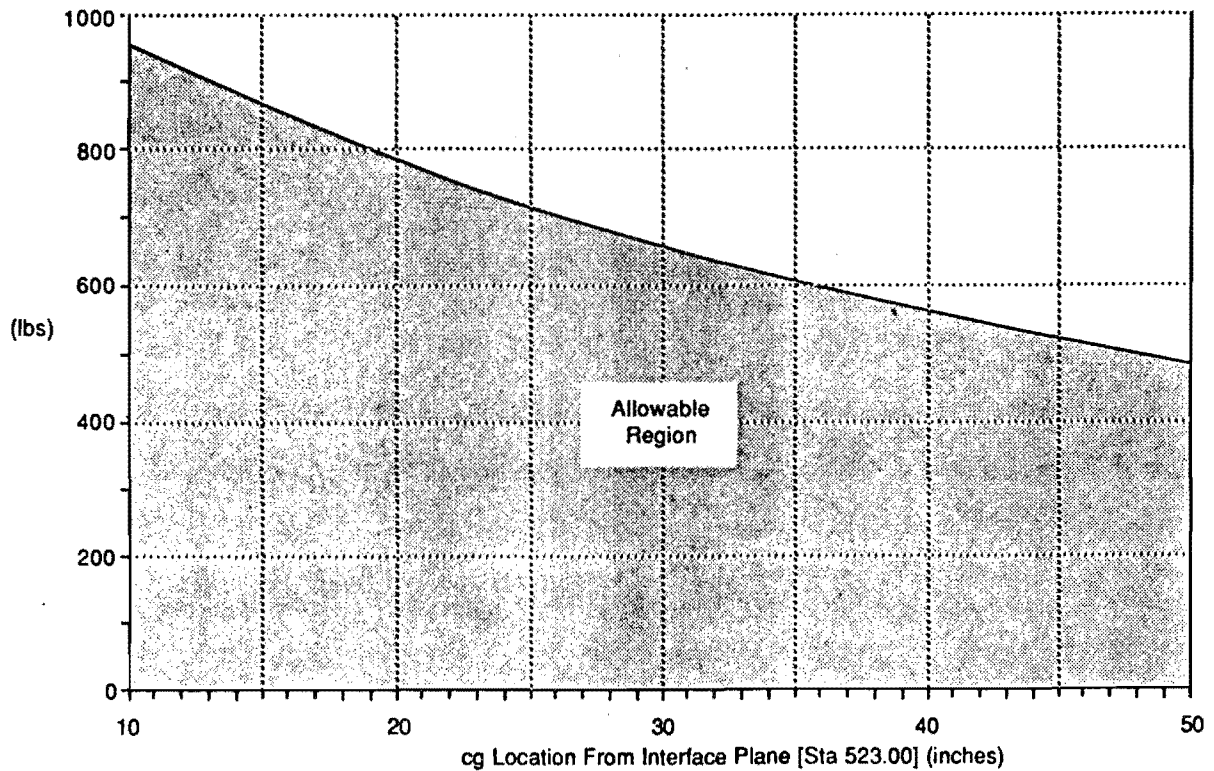

Figure 6 Payload Mass vs. CG Location

each side. It is anticipated that for most applications, a customer-supplied payload adaptor will be bolted directly to the deck. In other cases, a payload adaptor can be designed by OSC to specific payload requirements, or if the payload and third stage are to remain attached throughout on-orbit operations, the payload can be mated directly to the bolt hole circle. The payload can be provided with electrical power prior to launch and discrete commands for payload events sequencing. Up to eight (8) discrete sequencing commands, generated by the Pegasus flight computer can be tied directly to the launch vehicle sequence timing. Payload telemetry downlink while attached to the carrier aircraft and/or during launch can be provided using the Pegasus telemetry system by employing an optional payload telemetry multiplexer. Up to 12 kbps of the 56 kbps telemetry stream is available for optional payload telemetry.

Environments

Figure 7 summarizes the dynamic, thermal and acoustic environments that will be experienced by the payload in a direct insertion orbital launch mission, and assumes use of the NASA Dryden B-52 research aircraft. For suborbital and depressed atmospheric flight trajectories, environmental specifications can

Accelerations at Payload Interface

Flight Mode	\ddot{X} (G)	\ddot{Y} (G)	\ddot{Z} (G)	$\ddot{\theta}_x$ (rad/sec ²)	$\ddot{\theta}_y$ (rad/sec ²)	$\ddot{\theta}_z$ (rad/sec ²)
Captive Carry	+9 -8.8	+822 -922	+3.5 -1.4	±.74	+2.1 -1.5	±.57
Powered Flight	+0 -8.5	±.5	+2.8 -1.0	±.2	±.2	±.2

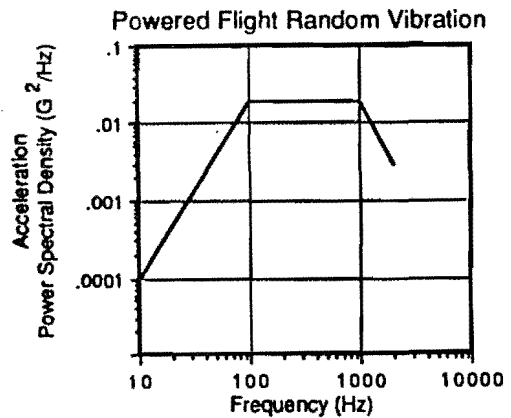

Ambient Thermal Environment

70 ± 5° F	Ground Operations
70 ± 30° F	Carrier Mate and Taxi
-70 F min	Carrier Flight (Heater Power Available)

Note: Ascent Heating Rate is Negligible

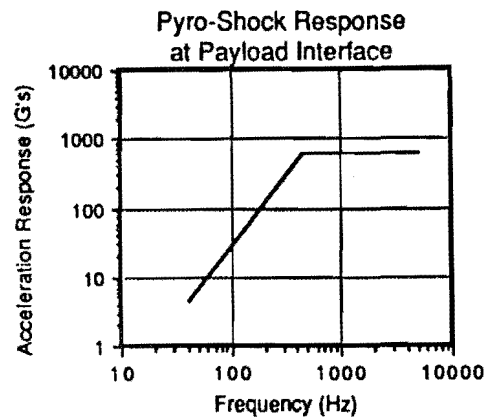

Figure 7 Pegasus Payload Environments

be developed based on specific mission requirements and flight vehicle design limits.

Acceleration - The flight loads are maximum loads; the actual flight transverse and longitudinal accelerations are dependent on the flight trajectory necessary to achieve the desired orbit.

Vibration - The vibration level shown is a worst case environment for motor ignition and burn, and is independent of axis.

Shock - The pyrotechnic shock environment experienced by the payload is dominated by third stage separation, with the other separation shocks being subordinate. Shock sources on the avionics structure are mounted so as to provide attenuation to shock levels below those of the payload fairing separation.

Thermal - Mating of the payload Pegasus flight vehicle and all close-out is carried out in a temperature-controlled working area at 70°F ± 5°F and 40% ± 10% RH. If required, payload mate and close-out can be performed in a clean tent (class 100,000 or better) environment. During ground operations, following closure of the payload fairing, the payload thermal environment will be temperature and humidity controlled to 70°F ± 30°F and 40% ± 20% RH, until just prior to carrier aircraft taxi and takeoff.

At launch altitude the ambient air temperature is approximately -70°F . Depending on the launch location requirement of the specific mission, sufficient time may be spent aloft to produce low steady-state payload temperature. For payloads that require heaters to maintain temperature limits on sensitive components, limited amounts of 28 VDC power is available during captive carry.

Acoustic - Acoustic noise is much lower than pad reflected noise on a ground launched vehicle. The actual acoustic noise environment inside the payload fairing will be experimentally characterized during the first several flights.

On-orbit Capabilities

Standard services are provided to assist in initial on-orbit operations of the payload. These services are designed to be flexible to allow mission designers the greatest freedom in developing the payload acquisition, checkout and separation sequence that best meets the requirements of the payload and the mission. Following orbit insertion, the Pegasus third stage executes a series of prespecified commands contained in the mission data load to provide the desired initial payload attitude prior to payload separation. Either an inertially-fixed or spin-stabilized attitude may be specified.

If an inertial attitude has been specified, orientation of the payload and third stage can be achieved to $\pm 2.0^{\circ}$ angular position and $0.0^{\circ}/\text{sec} \pm 0.1^{\circ}/\text{sec}$ angular rate in each axis. For a spin-stabilized attitude, the maximum spin rate achievable will depend on the spin-axis moment of inertia of the payload. The RCS provides up to 1,000 lb-in-sec total impulse for spin-up. Orientation of the payload/third-stage spin axis is achieved to $\pm 2^{\circ}$ and spin rate to $\pm 0.2^{\circ}/\text{sec}$.

Payload Integration Support

Support engineering and analysis is provided to the payload supplier to assist in integration of the payload and payload adaptor with the Pegasus flight vehicle. This activity comprises the development of interface drawings and a payload interface control document ICD, development of payload mechanical and electrical integration procedures, analysis to determine predicted thermal, acoustic and vibration environments for the mission trajectory specified, a six DOF trajectory optimization to the specified initial orbit, and development of the mission data load (MDL) including maneuvers required for initial on-orbit attitude acquisition. A combined third-stage/payload spin balance, which would be required for precise spin-stabilized attitude acquisition, is also available payload support service. Facilities will be provided at the final integration point to provide payload

suppliers with equipment, clean tents and other support services to allow quick and easy payload preparation and integration with the Pegasus vehicle.

Conclusion

The Pegasus vehicle concept provides cost effective launch opportunities for small satellite applications. The vehicle's launch capability is sufficient to support a wide variety of small satellite applications. The air launch concept provides unique operational capabilities and flexibility in selecting optimum launch points. The ability to conduct launch operations over open ocean areas, far from populated areas, can significantly reduce range safety concerns.