

**STEP INTEGRATION TO TAURUS  
FIRST FLIGHT PAYLOAD LAUNCH PROCESSING**

Stephen Nichols  
Defense Systems, Inc.  
McLean, VA 22102

Don Turner  
TRW Space and Technology Group  
Chantilly, VA 22021

ABSTRACT

The first flight of the Orbital Sciences Corp. (OSC) TAURUS launch vehicle is with a space vehicle developed by TRW and DSI under the Air Force Space Test Experiment Program (STEP), that contains several scientific experiments. The experiments have a demanding cleanliness requirement; the satellite requires status monitoring and battery maintenance during launch operations. OSC developed the TAURUS launch vehicle in response to the Advanced Research Project Agency (ARPA) Standard Small Launch Vehicle (SSLV) program. The Taurus system is composed of a flight vehicle and ground support equipment designed for easy transportability and rapid setup and launch on an unimproved concrete pad.

TRW provides system engineering on the STEP program, and DSI designed and built the STEP spacecraft. The spacecraft is an evolutionary design based on previous DSI satellite designs. A TRW propulsion system provides orbital adjustment capability. The space vehicle is approximately 36 " in diameter, 72 " high and weighs almost 1100 pounds when in flight configuration.

The challenge was to maintain the requirements in a low cost environment with minimal support from an established infrastructure. This was achieved by the process of encapsulating the satellite in the fairing in a clean room before transport and mate to the launch vehicle. Rehearsals were held at the OSC facility in Arizona in November, 1992 and February 1993, and at Vandenberg AFB, CA in June 1993 to develop the procedures necessary for mission success. The TAURUS initial launch capability is planned for November 1993.

INTRODUCTION

Taurus is being developed by the Orbital Sciences Corp. (OSC) to provide a capability to launch small satellites. The fact that Taurus requires no fixed launch site, equipment

or standing army coupled with the Taurus built-in streamlined testing approach results in reduced launch costs. TRW and DSI are providing a satellite developed for the Air Force, for the first Taurus flight. This satellite is a part of the

multiple-satellite STEP program and is designated Mission 0. The launch vehicle is derived primarily from Pegasus hardware with the addition of a MX Peacekeeper motor for Stage 0 for launch from a simple concrete pad.

A series of integration tests (called Pathfinders) were performed to develop and validate the processes used at the launch site. These Pathfinders have enabled the space vehicle payload to validate mechanical integration, electrical integration and site-specific procedures.

Launch site procedures to be used by the space vehicle payload include initial processing at a payload processing facility at the launch site, encapsulation in the fairing, transportation to the launch pad, integration with the launch vehicle and final checks before launch.

#### CONTRACT PHILOSOPHY

The Air Force has used the Space Test Program historically to advance hardware technologies, operational strategies, and major systems development as a precursor to full scale integration with major space systems. The Space Test Experiments Program (STEP) continues that tradition and goes further to incorporate innovative strategies as well. Significant among these is the following:

- Contracting a fixed price for all spacecraft core items ordered from a

Variations in Quantity (VIQ) matrix established at the time of overall STEP contract negotiation.

- Authorizing the contractor to implement industry standards in lieu of military standards for design, development, production and quality assurance for core items.
- Performing mission integration by contractor mutual agreement of interface control specifications in lieu of an independent mission integration management function.

#### SPACE VEHICLE DESCRIPTION

The payload is a space vehicle (SV) developed under Air Force contract. The space vehicle consists of the spacecraft and the experiment. TRW, as the prime contractor, performs systems engineering and supplies software and several major subsystems including TT&C, attitude control and propulsion. As the subcontractor, DSI designed and developed the spacecraft portion of the space vehicle. The experiment was procured on another Air Force contract.

The SV is a Class C spacecraft designed to support the operation of seven major experiments over a design life of one year, with a reliability of 90% over the design life. The vehicle will be launched into a circular polar orbit

with an altitude of 300 nautical miles by a Taurus launch vehicle. Attitude control to  $\pm 0.5$  degrees is required. To comply with these requirements, the SV is equipped with a propulsion, attitude sensing, and attitude control system.

The SV structure is a 12-sided truncated cylinder with a diameter of 37.5 inches across opposite corners, and a height of approximately 76 inches (not including a companion satellite attached to the upper surface of the SV). Weight of the SV is 1100 lbs. (nominal). The overall structure is formed by attaching together six segments that are described below.

#### LV Separation System

This consists of the mechanical components and electrical separation connectors that attach the payload to Taurus, consisting of the Mission 0 SV and a companion satellite. The system transfers launch loads between the LV and the payload and provides separation of the Mission 0 SV from the Taurus once in orbit.

#### Adapter Module

The adapter module provides the structure to contain the propulsion system. It is the lowest of the four modules and interfaces with the LV via a Marman ring/V band attachment and separation mechanism.

#### Core Module

The core module attaches to the upper surface of the adapter module. It contains the

electrical power control system and batteries, the communications subsystem, the Attitude Determination and Control System (ADACS), and the command and data handling subsystem for the experiment and for operation of the satellite.

#### Payload Module

The payload module attaches to the upper surface of the core module and provides volume for the experiments.

#### Deployment Module

The deployment module is an independent structure to which deployment mechanisms (i.e., antennas, sensors, etc.) mount. The deployment module bolts directly to the payload module.

#### Companion Spacecraft Separation System

This consists of the mechanical components and electrical separation connectors that attach the companion spacecraft to the upper portion of the Mission 0 SV. The system transfers launch loads between the LV/Mission 0 SV and the companion spacecraft. It provides separation of the companion spacecraft from the Taurus/Mission 0 SV once orbit is achieved.

#### Physical Characteristics of the STEP Mission 0 SV

The overall configuration of the SV is shown in Figure 1 in flight configuration. Figure 2 shows the stowed configuration on the payload adapter ready for launch.

The STEP Mission 0 SV supports several experiments and two experiment interface subsystems. These are comprised of sensors that supply data to prototype data processors for analysis and transmission to the ground. They are configured on a common communications bus, the 1553, to communicate with each other, to store data on a mass memory unit (MMU), to accept the commands from the SV processor, and to downlink telemetry through the SV. The Mission 0 experiments are housed and supported in the deployment and payload modules of the SV.

The presence of sensitive sensors requires that the spacecraft be maintained in a clean environment. Normally the spacecraft requires the environment to be class 100,000 or better for .5 micron particles. When protective covers are removed, class 10,000 or better must be maintained.

#### SV Support Systems

These consist of Electrical Ground Support Equipment (EGSE) and Mechanical Ground Support Equipment (MGSE).

The EGSE consists of a combination of components developed by DSI/TRW and off-the-shelf electrical test components. These are integrated into a series of racks for ease in operation and transportation. The EGSE provides the following capabilities:

- Command and telemetry to and from the SV.

- Hardcopy printout of command and TTM data.
- Keyboard access to the spacecraft for command and operations.
- Automated loading of complex multifaceted commands.
- Access to the experiments for commanding and data output.
- Monitor of advance firing circuitry for stray current/voltage.

MGSE consists of hoisting slings, mounting brackets, handling fixtures and other individual fixtures that will be used in handling of the SV after assembly.

#### Taurus Description

The Taurus launch vehicle is a transportable small launch vehicle developed to meet the requirements of the ARPA SSLV program. It is a four stage, inertially guided, 3-axis stabilized, solid propellant launch vehicle. The Pegasus-derived motors retain their Stage 1, 2 and 3 designations from that program. The Thiokol TU-903 stage, derived from the Peacekeeper program, is designated stage 0. Figure 3 shows a drawing of the Taurus configuration. Contract requirements include full launch system ground transportability; launch from a dry concrete pad; launch of a 1900 lb payload into a 400 nm circular polar orbit from Vandenberg AFB. The Taurus launch support equipment is

shown in Figure 4.

Physical characteristics of the Taurus launch vehicle are:

System Height	90.4 ft
Payload Fairing	
Diameter	4.83 ft
Height	21.7 ft
Gross Mass	150,000 lb
Launch Site	Vandenberg AFB, CA Transport- able Pad

The mission goal for this launch is to place the fully functional STEP space vehicle and companion spacecraft into the desired orbit. To satisfy this goal Taurus must:

- Provide a payload adapter to attach and support the payload.
- Provide environmental protection and control of the payload during pre-launch and launch.
- Enable space vehicle functional performance verification.
- Properly sequence through ignition, burn and separation phases of each stage.
- Jettison fairing at an acceptable altitude.
- Achieve conditions for satisfactory orbit injection.

#### INTEGRATION OPERATIONS PROCEDURES

Operations required to be performed at Vandenberg AFB to

integrate the STEP space vehicle to the Taurus launch vehicle are performed at two locations. Payload processing facility (PPR) operations are:

- Final space vehicle preparations.
- Installation on LV payload adapter.
- Load fuel on space vehicle.
- Install Solar Arrays
- Encapsulate space vehicle with fairing.

Launch Site Operations are:

- Transport to launch site.
- Integrate with Taurus launch vehicle.
- Perform final checks before launch.

Figure 5 shows the flow of these operations. They must be carried out while maintaining the required levels of cleanliness and conforming with the Vandenberg AFB safety rules. The use of the Taurus launch vehicle, with its streamlined processing plan, allows the work to be performed in a cost-effective manner.

Initial PPR SV preparations includes unpacking, setting up the GSE and performing functional checks to verify the readiness of the SV for launch integration. All equipment in the processing room must be cleaned, including the fairing, and personnel are required to wear cleanroom clothes.

The space vehicle is hoisted by an overhead crane and placed on the payload adapter. Electrical connections are made between the space vehicle and payload adapter. These connections provide a means to monitor the spacecraft inhibit status, battery health and fuel system stability. Figure 6 shows the electrical connections during Pathfinder rehearsal.

Hydrazine fuel is loaded onto the space vehicle for the on-orbit propulsion system. From the time fuel is loaded until launch, the pressure and temperature must be monitored continually.

As seen in Figure 1, STEP has two sun-oriented solar array "wings". When stowed for launch, as shown in Figure 2, most of the space vehicle is covered, so they are the last major components to be installed. Before solar array installation, the space vehicle is given a thorough cleaning. Figure 7 shows the Pathfinder rehearsal of the installation of the solar arrays. Figure 8 shows the process of folding one of the array wings.

The fairing is installed one half at a time. After the first half installation, the space vehicle is cleaned for the final time as shown in the photo of a Pathfinder rehearsal in Figure 9. When the second half is installed, the space vehicle is provided filtered, environmentally controlled air by a portable air conditioner that continuously supports the encapsulated space vehicle until launch. This feature

allows the launch vehicle to be assembled in a simple environment without elaborate structures or gantries. Figure 10 shows the encapsulated space vehicle attached to the GSE ring.

The move from the payload processing facility to the launch site, a distance of 25 miles, is accomplished by placing the following items on one standard flatbed truck: Primary and backup diesel generators; An Air Conditioner: The Encapsulated Payload in the vertical orientation; and An Inhibit Monitor Unit. Figure 11 shows a small box on the side of the GSE ring under the fairing. This box is the Inhibit Monitor Unit. Figure 12 shows the loaded flatbed truck during Pathfinder rehearsal.

Integration of the environmentally controlled encapsulated payload with the Taurus launch vehicle is accomplished at the launch site in a tent. Before the payload arrives, the first, second and third stages are horizontally mated, along with the avionics module, on the Assembly and Integration Trailer (AIT). Figure 13 shows the arrival of the flatbed truck at the launch pad during Pathfinder rehearsal. The scaffolding in the background surrounds the first stage that has been erected on the launch pad. The encapsulated fairing is lifted off the truck, rotated to a horizontal position and placed in a moveable cradle. Figure 14 shows the Pathfinder rehearsal of the rotation. Electrical connections are made

and verified, the fourth stage is attached to the payload adapter and then the payload adapter is attached to the avionics module.

Once the payload is mated, the umbilical provides electrical access to the STEP spacecraft until liftoff. Copper wires run from the launch vehicle to the launch equipment van (LEV) where the spacecraft battery charger is located. The LEV is connected to the launch support van (LSV) by fiber optic cables. The payload engineer sits at a LSV console where the spacecraft critical parameters may be monitored.

#### INTEGRATION OPERATIONS DEVELOPMENT

A full-scale integration testing program for Taurus, using inert stages, was performed to develop and demonstrate the procedures required at the launch site. Four series of tests were performed.

Three of the Pathfinders were performed at OSC's Space Data Division in Chandler, Arizona, and the fourth Pathfinder was performed using the launch facilities at Vandenberg AFB. Pathfinder #1 was performed in August, 1992. A full-scale vehicle build-up was performed for the first time. The second Pathfinder in November, 1992, included the use of a STEP spacecraft mockup. This test allowed the practice of key STEP integration procedures including:

- Mating to the payload adapter.

- Solar Array Installation.
- LV Fairing Installation
- Transport to Launch Site.
- Payload Integration with the Launch Vehicle.

The third Pathfinder was performed in January, 1993. This test demonstrated the capability of the launch vehicle to maintain the required cleanliness and verified the electrical interfaces.

The fourth Pathfinder, performed at Vandenberg AFB, California used the same facilities for rehearsal that will be used for flight. Payload processing is performed in the old Shuttle facilities. Figure 15 shows the layout of the equipment in the clean room. The build-up starts with a GSE Ring in the middle of the room. The Payload adapter is mounted to the ring, and the STEP spacecraft is mounted to the adapter. After fueling and solar array installation, the two fairing halves, which have been cleaned and stored in the room, are installed on the adapter.

The transport to the launch site was rehearsed following the intended route at Vandenberg AFB. The rehearsal included the maintenance of the payload cleanliness capability. Figure 16 shows the cleanliness achieved in a chart of particle counts versus time during transport rehearsal in Pathfinder #3.

Pathfinder #4 included a full electrical and mechanical integration rehearsal. The software to be used in the launch service van was also demonstrated.

#### CONCLUSION

The concept of a streamlined payload integration and launch from a simple pad, performed swiftly and without expensive, complex support equipment has been validated by the Pathfinder rehearsals. The Pathfinders demonstrated the capability to provide the required cleanliness, maintain the required safety inhibits, and provide for the required monitoring of the health and status of the space vehicle. The space vehicle is currently undergoing environmental test with a planned delivery to Vandenberg AFB in October and launch in November.

#### REFERENCE

Stoecker, T.; Frazier, S.; Padavano, J.: The Taurus Launch Vehicle Design and Capability; A I A A 9 2 - 3 8 6 8 , AIAA/SAE/ASME/ASEE 28th Joint Propulsion Conference. Nashville, TN. July 6-8, 1992.



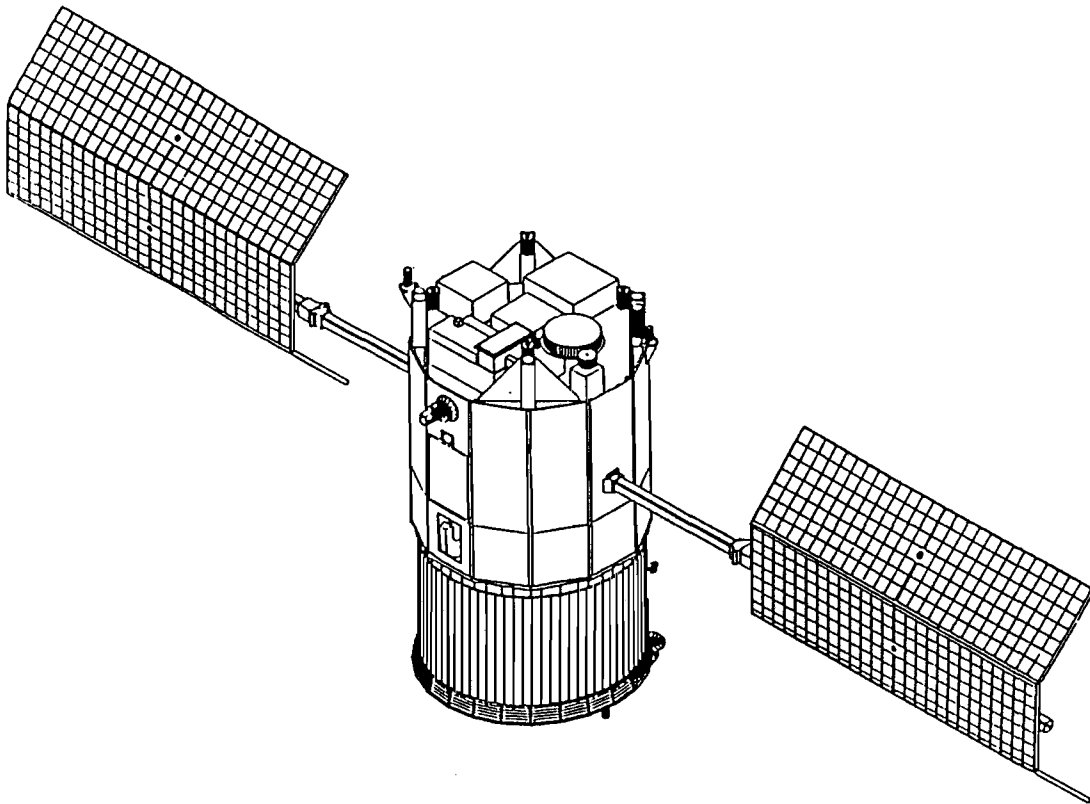

Figure 1: STEP Space Vehicle On-orbit

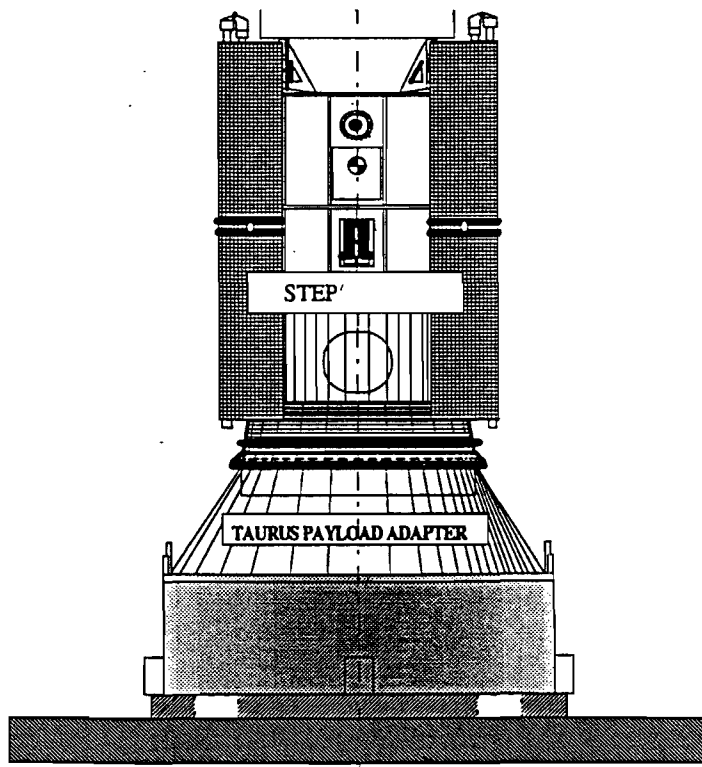

Figure 2: STEP Space Vehicle in Launch Configuration

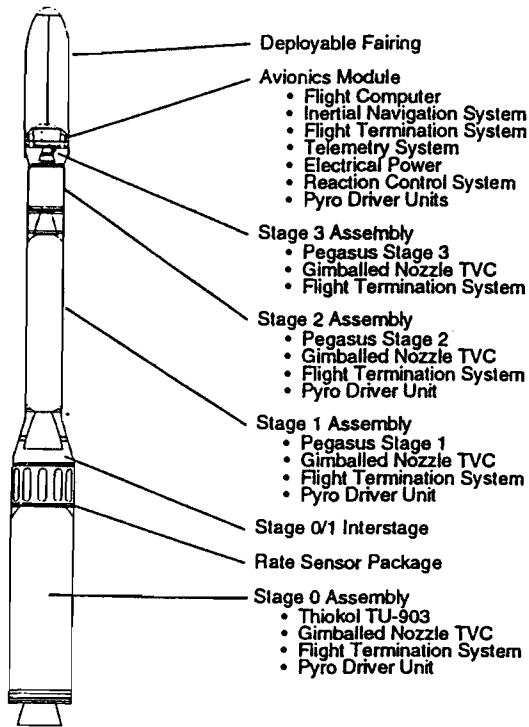

Figure 3: Taurus Launch Vehicle

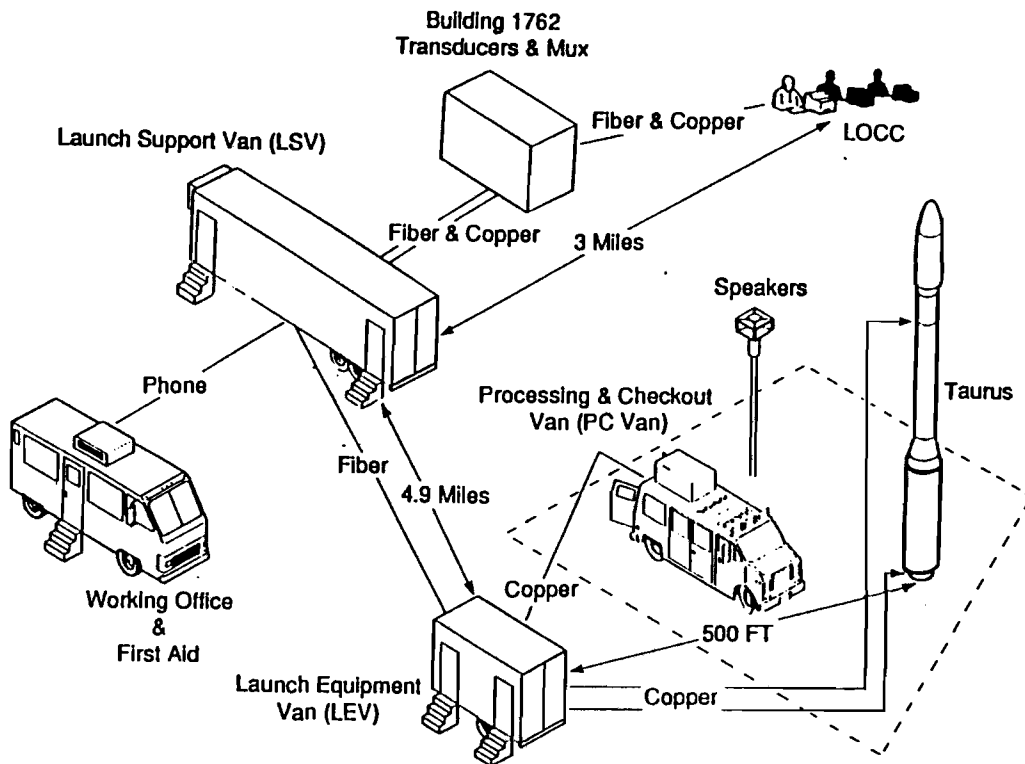

Figure 4: Taurus Launch Support Equipment

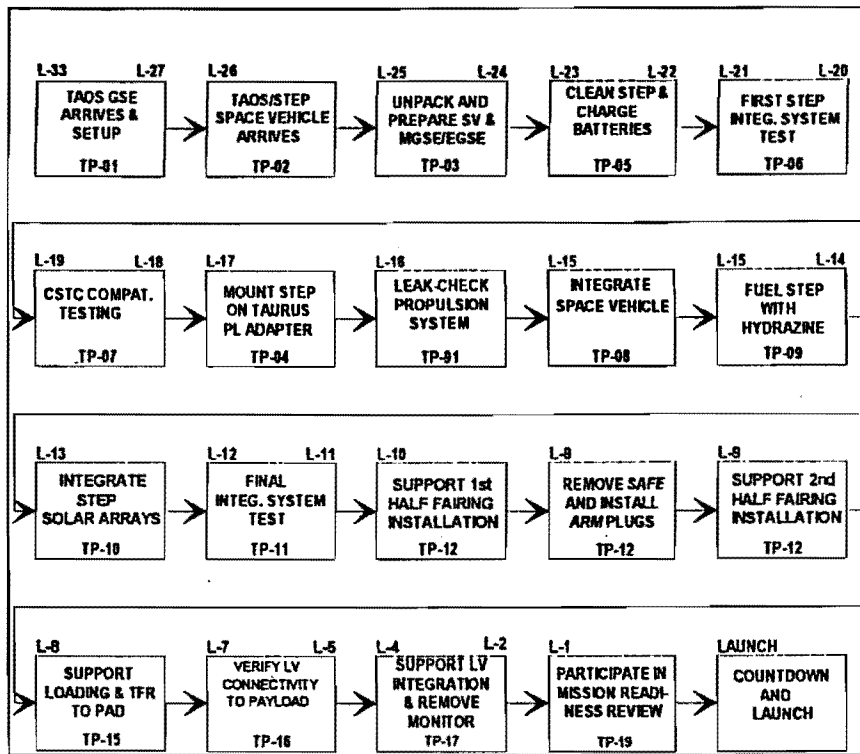

Figure 5: STEP Launch Site Integration Flow

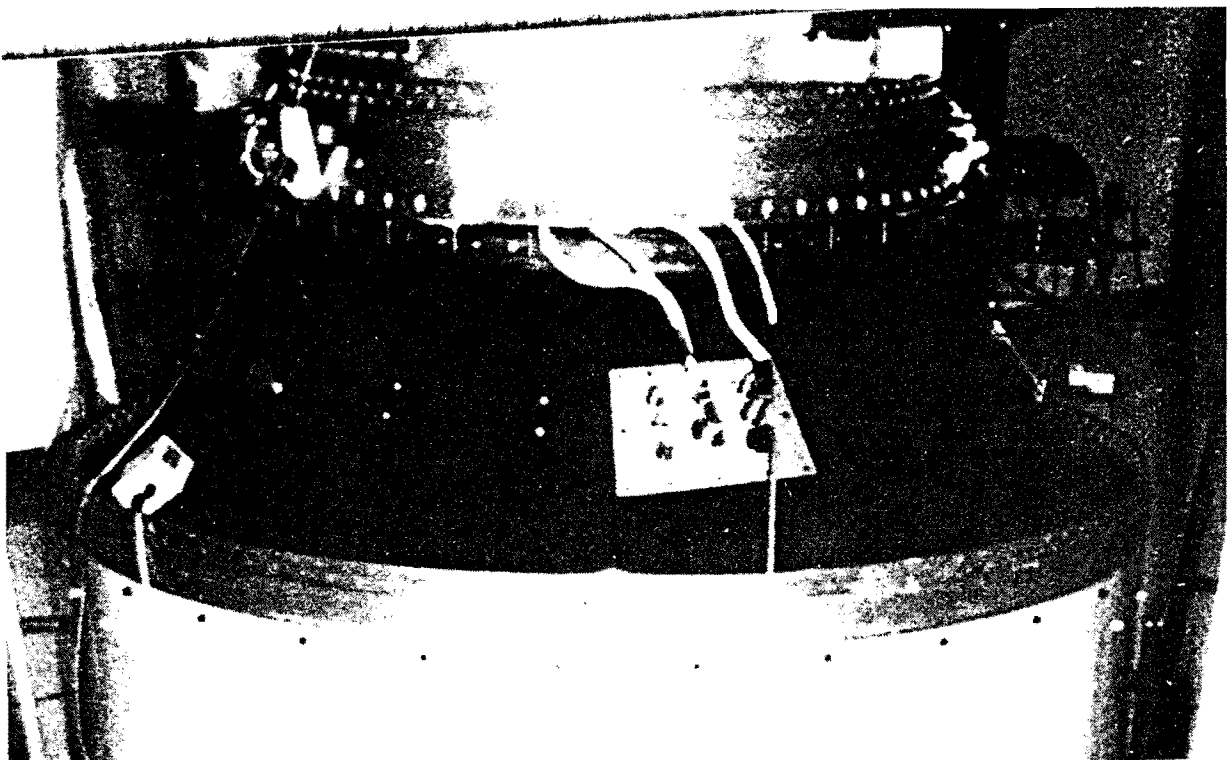

Figure 6: STEP Interface Connections to the Taurus LV

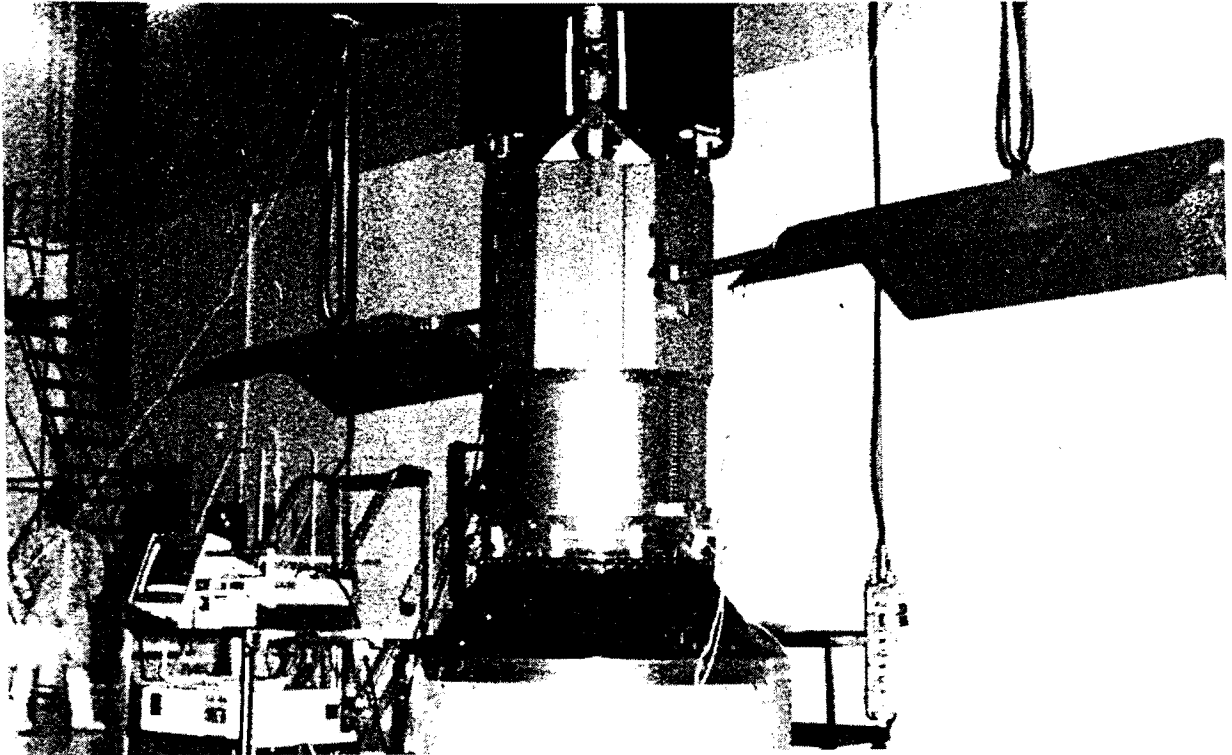

Figure 7: Installation of STEP Solar Arrays

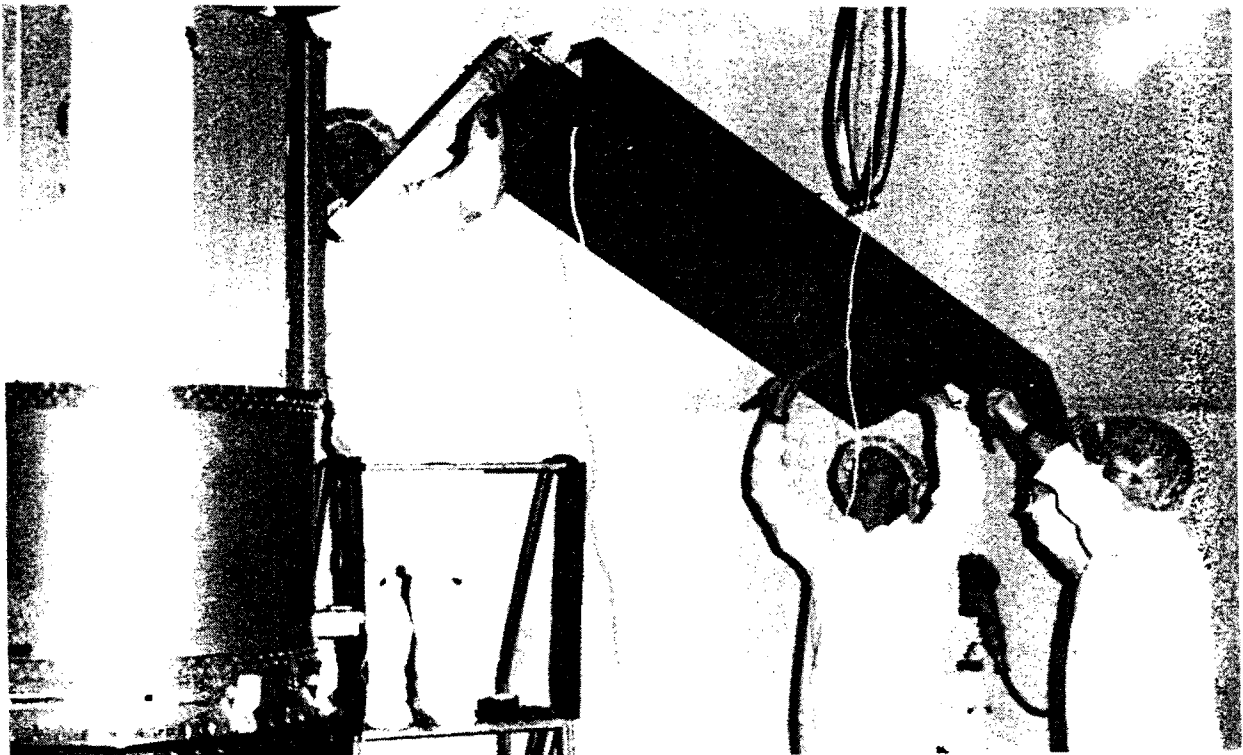

Figure 8: Folding Solar Array to Launch Configuration

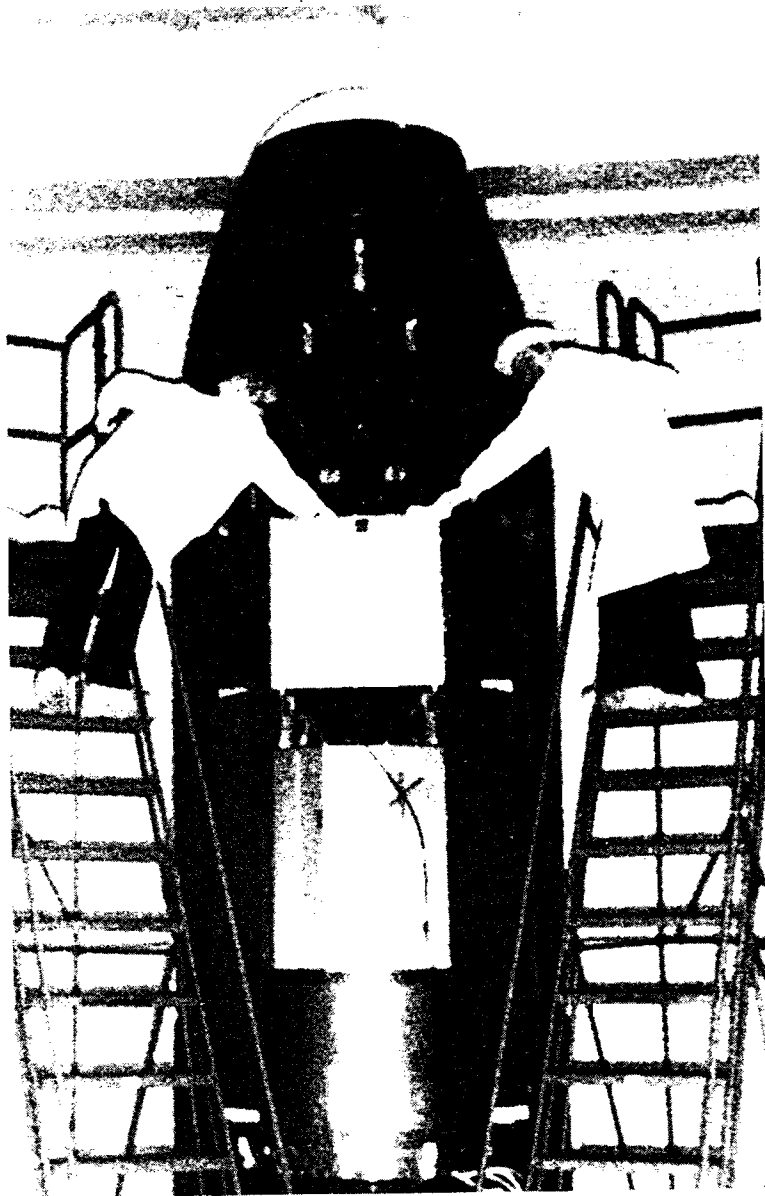

Figure 9: Final Space Vehicle Cleaning

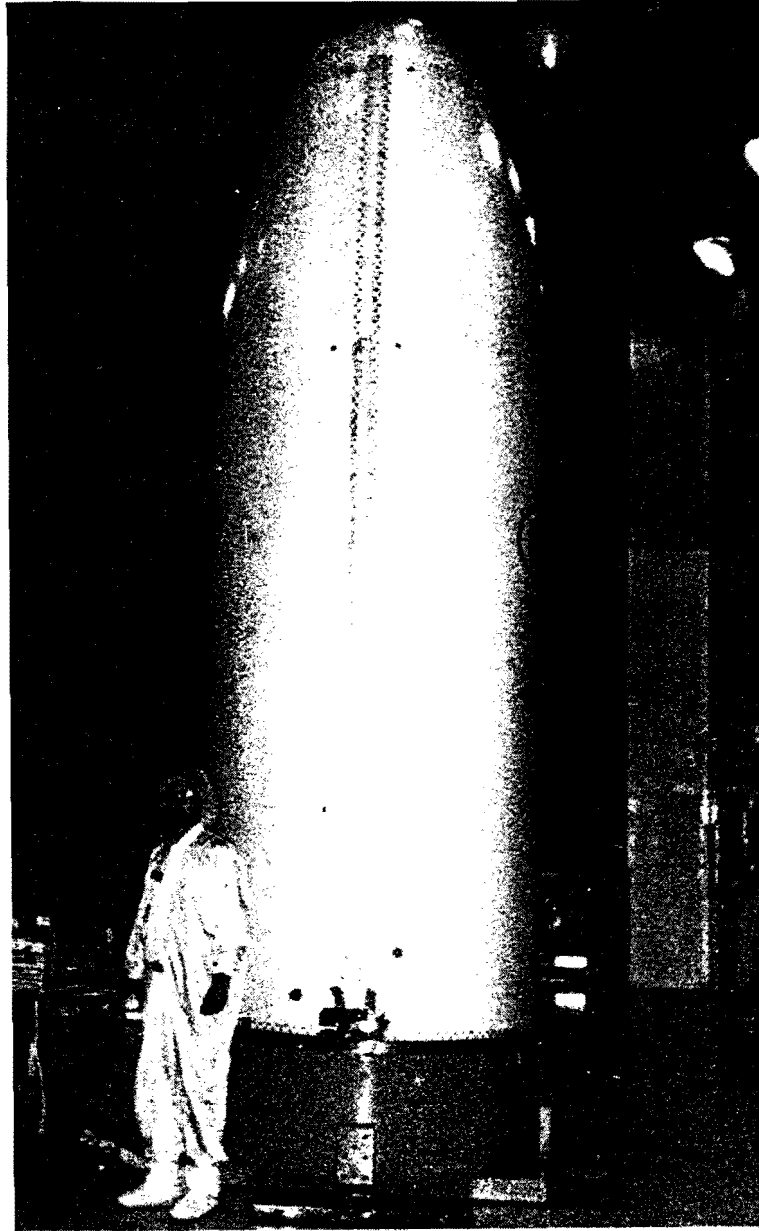

Figure 10: Taurus Fairing on GSE Ring

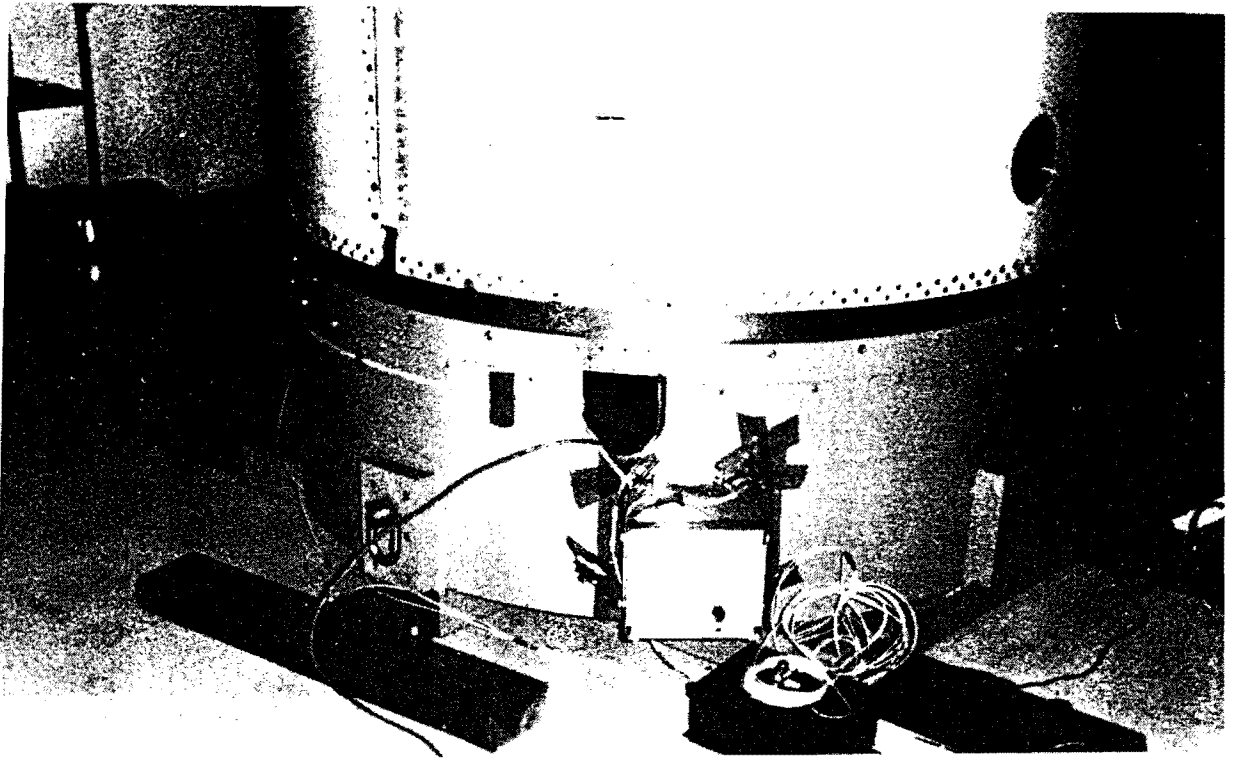

Figure 11: Inhibit Monitor Unit Mounted on GSE Ring

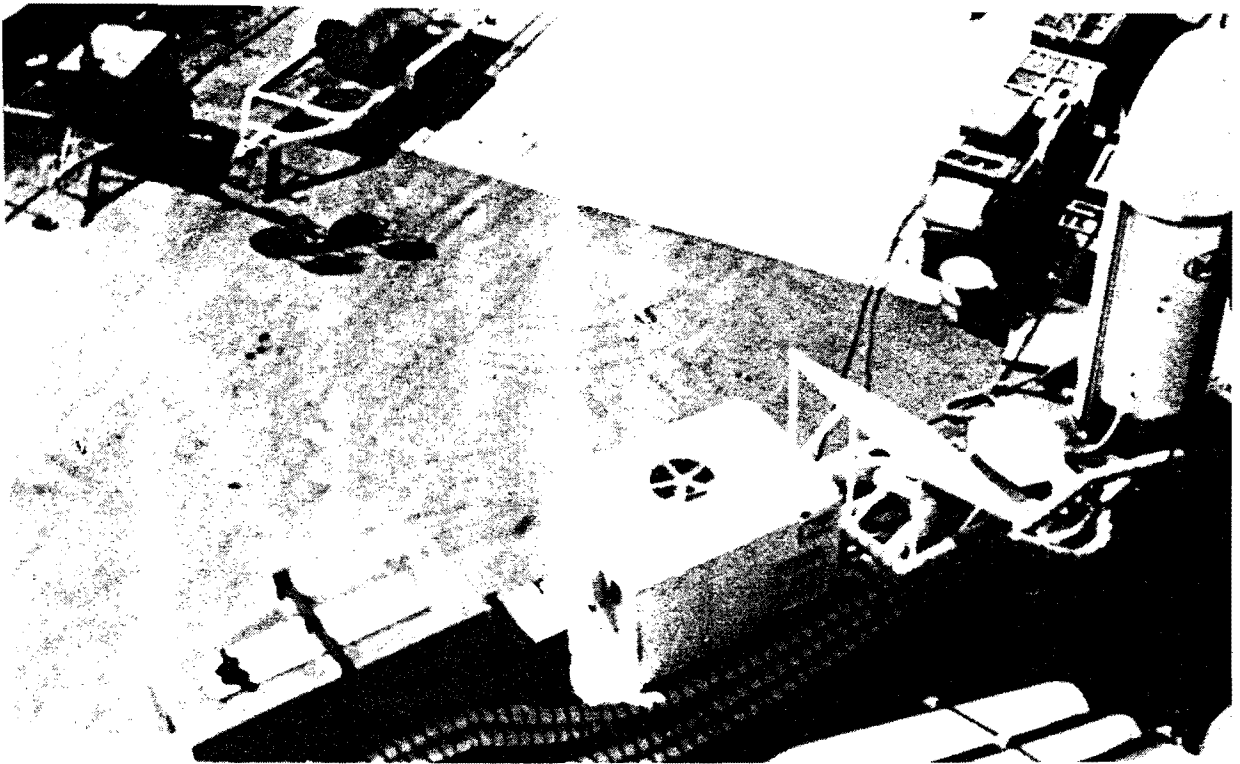

Figure 12: Truck with Generator, Air Conditioner and Fairing

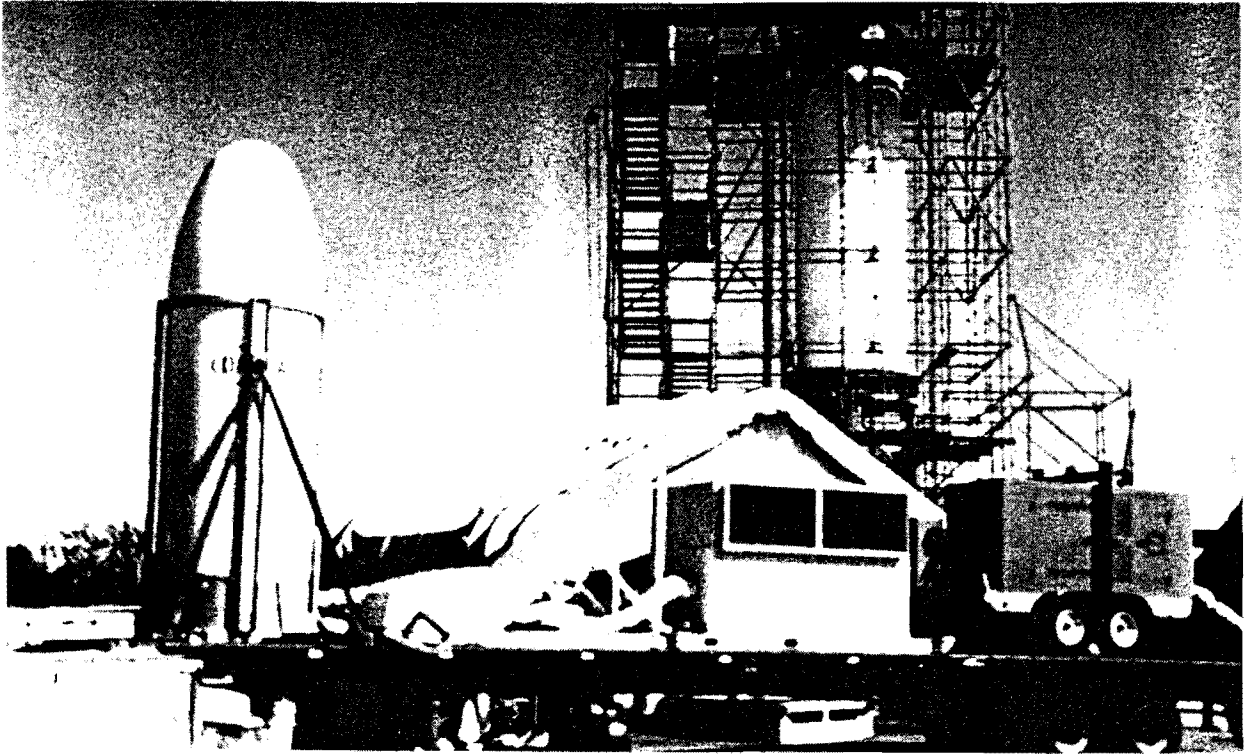

Figure 13: Payload Delivery Truck at Launch Site



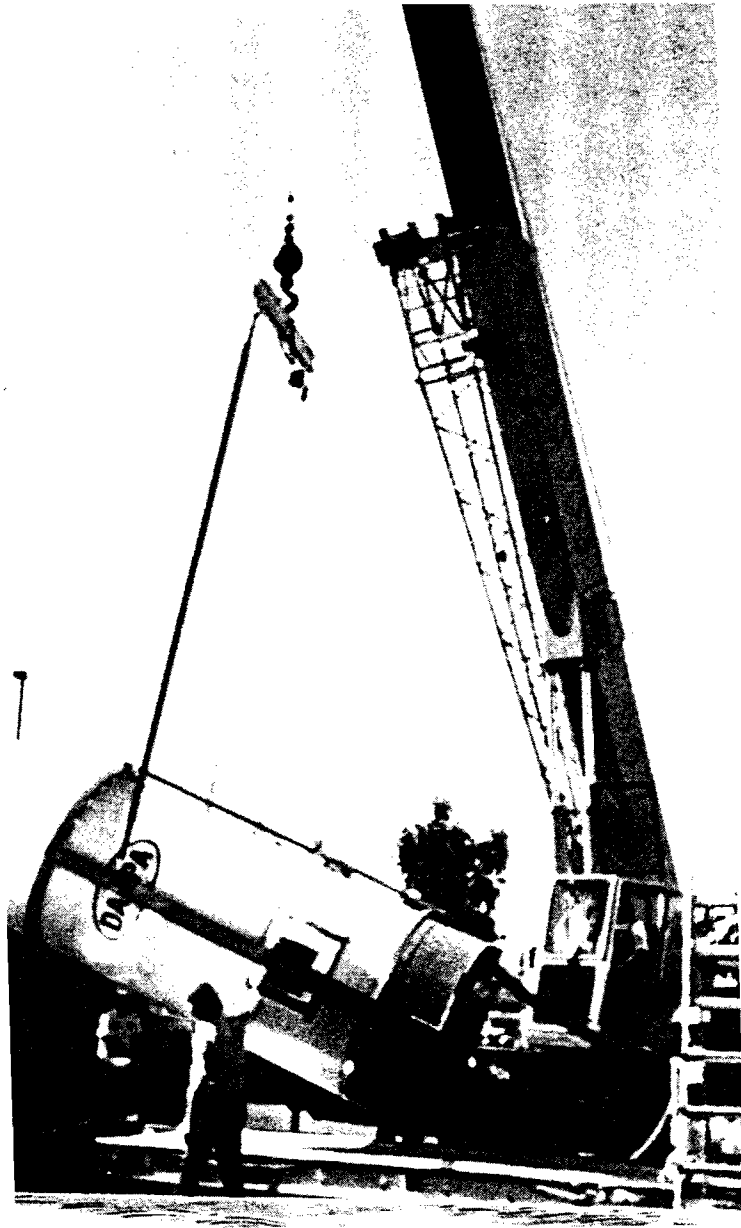

Figure 14: Rotation of Fairing to Horizontal Position

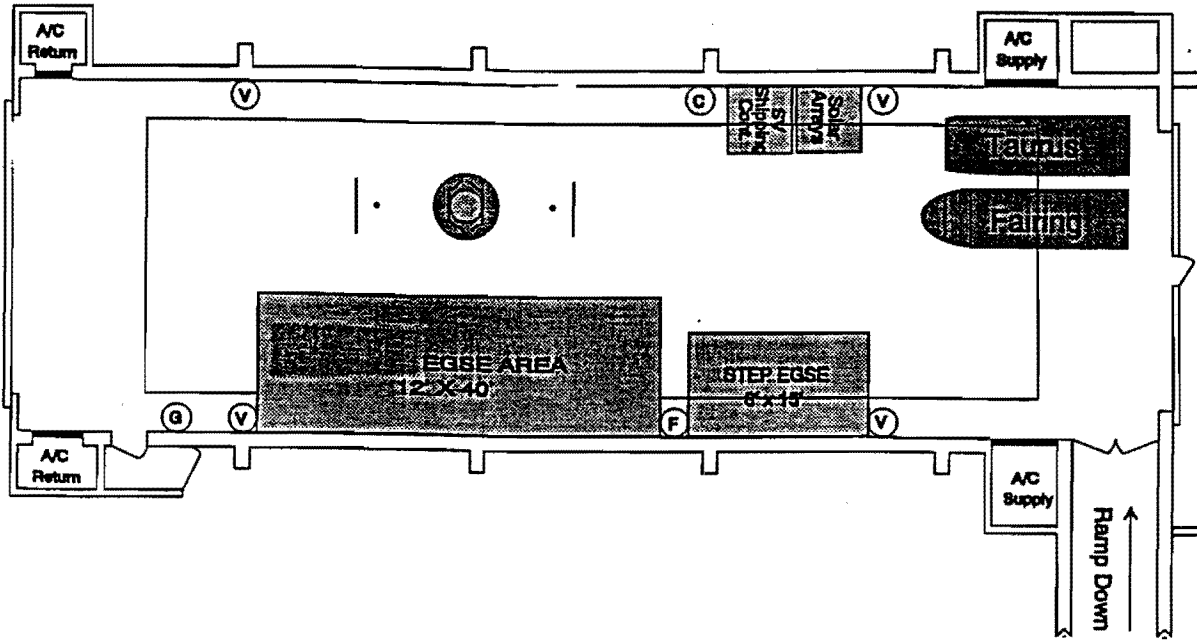

Figure 15: STEP Payload Processing Clean Room

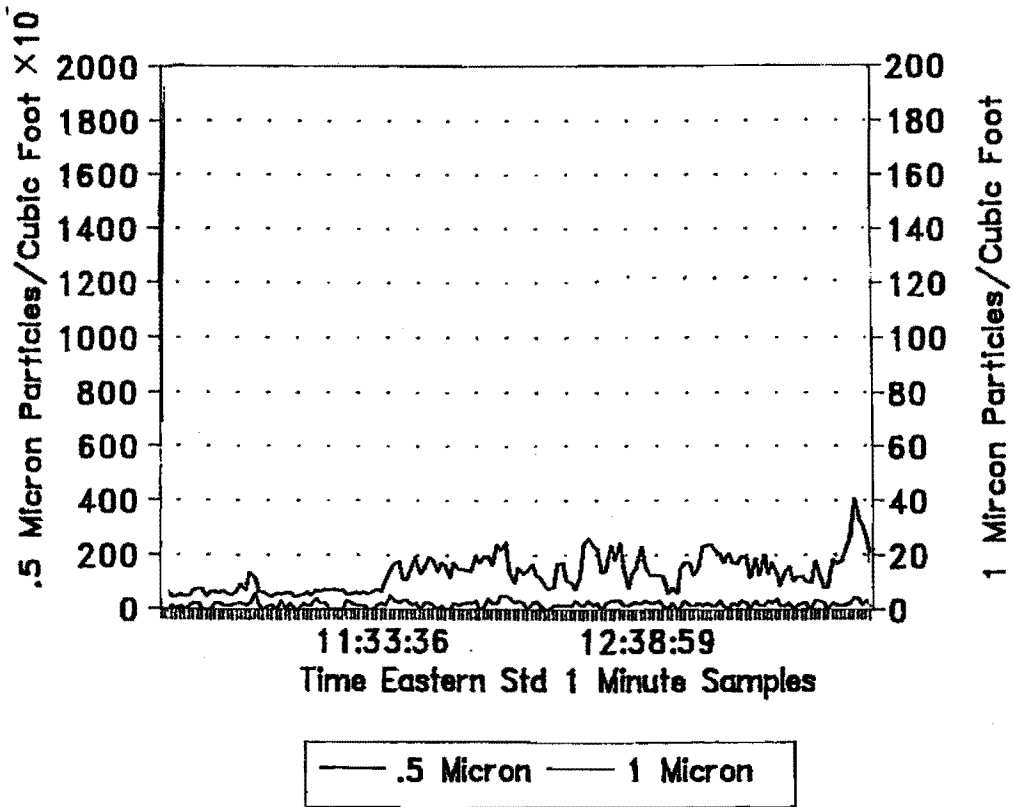

Figure 16: Particle Count during Pathfinder Transportation