

Collocated Compact UHF and L-Band Antenna for Nanosatellite Applications

Rémi Fragnier, Romain Contreres, Baptiste Palacin, Kevin Elis,
 Anthony Bellion, Maxime Romier, Gwenn Le Fur, Tomasz Maleszka
 CNES : Centre National d'Etudes Spatiales
 18 avenue Edouard Belin, 31401 Toulouse, France ; +33 (0)5 61 28 36 91
 remi.fragnier@cnes.fr

ABSTRACT

In this paper a dual-feed collocated UHF and L-band antenna is described, based on a square array of tunable inverted F UHF antennas, and of one stacked circularly polarized L-band patch. Advanced miniaturization methods have been used to adapt the antenna for nanosatellite applications by limiting its footprint and volume, to fit in a cavity equal to half of a 4U standard volume (211x211x43mm). The UHF and L-band antennas have been designed and simulated as a single system using CST Microwave Studio software in order to optimize their performances at 400MHz and 1.7GHz.

INTRODUCTION

As standardization and miniaturization progress, the capabilities of nanosatellite platforms from 1U to 16U have increased over the last years and a demand appeared for compact antenna systems verifying mission-level requirements. As part of a new generation of Argos satellite systems, a nanosatellite program named ANGELS has been initiated by CNES [1]. Based on a 12U spacecraft bus, the ANGELS program aims to demonstrate a miniaturized Argos instrument (Argos Neo project) as a pathfinder for future data collection and IOT miniaturized payloads.

In order to receive the Argos beacon signals, a UHF-band reception capability at 400MHz is required and must cohabit with an L-band transmission system operating at 1700MHz dedicated to spacecraft and payload telemetry. The antenna system must therefore meet the following requirements:

- Volume limited to a 4U footprint (211x211mm) and a 45mm maximum height
- As lightweight as possible
- $|S_{11}| < -10\text{dB}$ over the UHF and L bands
- Right Hand Circular Polarization (RHCP)
- Gain coverage for $\theta \in [-66^\circ; 66^\circ]$ and $\varphi \in [-180^\circ; 180^\circ]$

A number of different antenna solutions exist and former Argos payloads featured dual-band UHF and mono-L-band quadrifilar helix antennas providing isoflux coverage over the Earth. Although these antennas provided optimum performances, they measured up to 60cm in height and were therefore not compatible with a nanosatellite structure and the use of miniaturization methods was considered. The Figure 1 shows an example of quadrifilar helix antenna manufactured by RUAG Space and installed in a former Argos payload.

As a radio-electric model of the antenna was to be proposed, optimized, built and its Radio-Frequency



Figure 1 : RUAG Space L-Band Quadrifilar Helix Antenna (<https://www.ruag.com>)

(RF) performances measured in a 5 months' timeframe only, a static antenna design was preferred over a deployable concept. A collocated compact antenna measuring 211x211x43mm ($0.3 \times 0.3 \times 0.06\lambda_0$ at 400MHz) is proposed, featuring a tunable square array of Inverted F Antennas (IFA) providing circular polarization (CP) in the UHF band, and a stacked patch antenna providing circular polarization in the L band. All given performances have been determined with a full-wave analysis using CST Microwave Studio software.

MINIATURIZED CP TUNABLE UHF ANTENNA

Capacitive IFA Rotating Array

In order to generate a circularly polarized signal within the limited allowed volume, a square array of four Inverted F Antennas (IFA) excited in phase quadrature (0° , 90° , 180° and 270°) was considered [2]. The use of IFA radiating elements in a sequential rotation array is a proved concept [3] and is motivated in our case by three aspects. First, IFA elements can be optimized to reduce their height at the cost of bandwidth, thus allowing a low-profile antenna. Second, it is an all-metal technology that is both lightweight and easy to qualify for space applications. Finally, their width can be

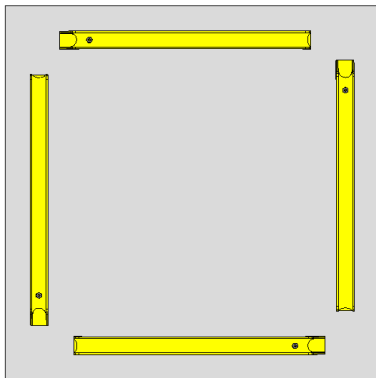

Figure 2 : UHF IFA Sequentially rotated Array

optimized to leave enough space between them to accommodate the L-band antenna. The sequential square array is shown on Figure 2. With this design, the resonant frequency of the array elements is obtained by optimizing their length and height.

It has been shown [4] that a capacitive loading at the open extremity of the IFA elements allows for a reduction of their length down to $\lambda/8$, this method has been implemented as a set of two parallel plates, one connected to the radiating element, the other resting on the ground plane. One IFA is shown in Figure 3.



Figure 3 : UHF Compact Tunable IFA

Due to the very small volume of the antenna ($0.3 \times 0.3 \times 0.06 \lambda_0$ at 400MHz), the close proximity of the cavity walls and the presence of the L-band antenna in the middle of the array, the operational bandwidth of the UHF array is both very narrow and very sensitive. In order to mitigate the risk of degraded performances due to the antenna environment (solar panels, other antennas, ...) that could shift its resonance frequency, a tuning capability was implemented by adjusting the height “h” of the capacitive gap. The Figure 4 shows the $|S_{11}|$ parameter of a single IFA element for different values of the parameter “h”, all other dimensions being equal. It can be observed that a shift in frequency of more than 6% is possible while keeping the antenna return loss performances compliant with required values.

4-Ports Quadrature Feeding Network

In order to realize the circular polarization of the UHF-antenna, the signal has to be equally divided and set in quadrature ($0^\circ, 90^\circ, 180^\circ, 270^\circ$).

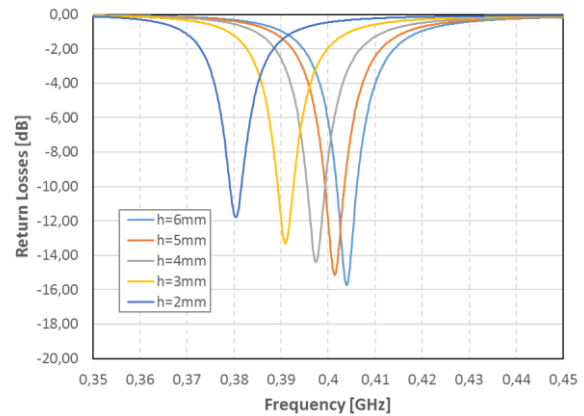

Figure 4 : UHF IFA Tuning Capability : S_{11} parameter as a function of the capacitive loading h dimension

Due to the short-time delivery, the (space qualified) discrete components were reduced to the minimum and the RF functions were mainly implemented with TEM line. The L-band antenna integrated in the middle of the UHF imposes a high compactness for the UHF feeding functions and a positioning flexibility.

The coupling between the IFA can be re-radiated passing through the circuit if the division function is made by simple splitters exhibiting a coupling between their 2 output ports (-6 dB for a symmetric division): the Axial Ratio (AR) would be dramatically deteriorated. To prevent this phenomenon, all the IFA couplings have to be absorbed by loads, at the cost of a few tenths of decibel of losses.

For these reasons, the circuit was implemented with three compact Wilkinson dividers and four delay lines. The performances of the UHF feeding network are presented on the Figure 5.

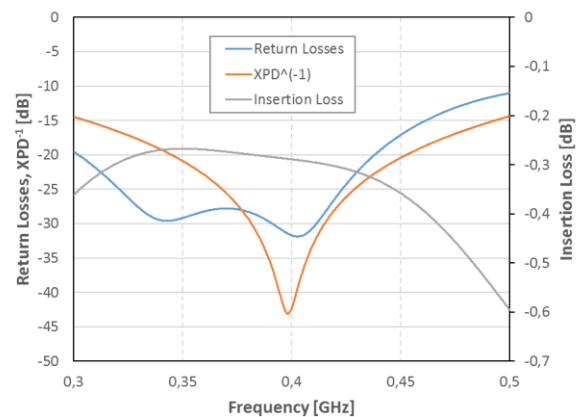

Figure 5 : UHF Feeding Network Performances

The return loss is much lower than -20 dB over a wide band. The cross-polarization presents a narrower bandwidth due to the presence of the delay lines: although it is sufficient for this application, it reduces the overall bandwidth of the full antenna. The circuit introduces an insertion loss of approximately 0.3 dB at the center frequency.

L-BAND CP ANTENNA

Stacked Circular Patches Antenna

As the antenna total height was not as much a constraint for the L-band as it was for the UHF band, a stacked patches antenna was considered to increase the bandwidth and therefore the immunity against the manufacturing and the dielectric constant deviations. The dielectric substrate used is Rogers TMM3 as this substrate is space qualified, has a low relative permittivity (3.27) and a high standard thickness.

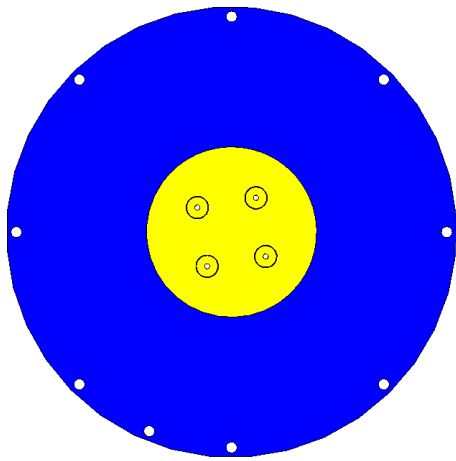

Figure 6 : L-Band Bottom Patch

As shown on the Figure 6, the bottom patch is fed by 4 ports in phase quadrature (0° , 90° , 180° , 270°). Although using only 2 feeding ports would have given decent CP performances, using 4 ports improves the polarization quality. Circular irises are inserted on each 4 ports in order to bring the feeding ports closer to the center of the patch while keeping a 50Ω impedance. This configuration allows for an easier accommodation of the feeding circuit below. The equivalent capacitance of the iris is low enough to avoid any ESD risk.

The return loss of the patch is presented on the Figure 7. The return loss has a bandwidth of 8% at -10dB which is enough to account for all the manufacturing deviation without degrading the performances.

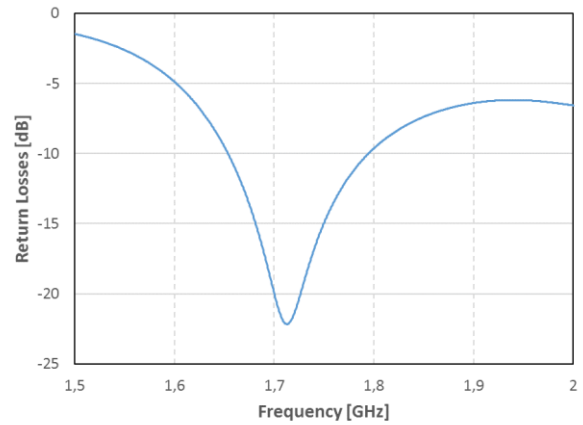

Figure 7 : L-Band Stacked Patch Return Loss

4-Ports Quadrature feeding Circuit

As the integration of the L-band antenna within the satellite deteriorates the axial ratio of the solution, it is necessary to ensure a good cross-polarization of the antenna alone and a 4-port feeding circuit is therefore proposed. It is composed of two hybrid couplers and one rat-race coupler as presented in the Figure 8.

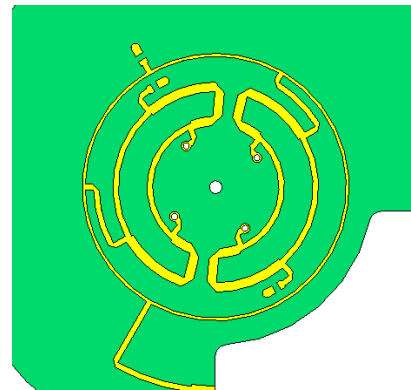

Figure 8 : L-Band Feeding Circuit

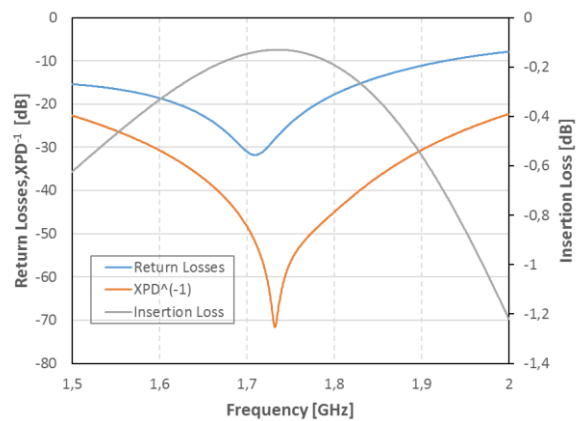

Figure 9 : L-Band Feeding Circuit Performances

The performances of the L-band circuit are presented on the Figure 9. Return loss and cross-polarization present very good performances with a operating bandwidth above 20%, and are fully sufficient for the considered application. An insertion loss of 0.2 dB is introduced at 1.7 GHz.

COMPLETE ANTENNA SYSTEM ANALYSIS

Integrated Collocated Antenna

Although both UHF and L-band antennas were pre-designed alone, the final optimization was performed by including both antennas in a single model and adjustments were made to the antenna critical dimensions. The final design dimensions are 211x211x43mm or $0.27 \times 0.27 \times 0.06 \lambda_0$ at 400MHz, as presented on the Figure 10.

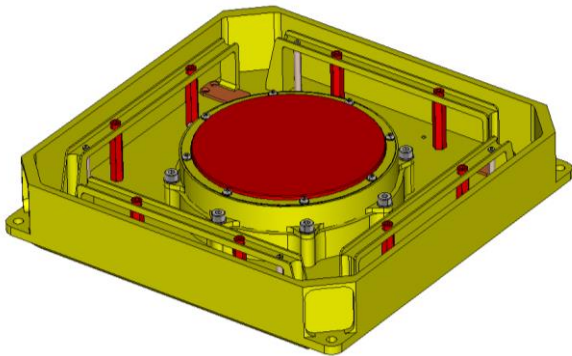

Figure 10 : Integrated UHF and L-band Antennas

The RF performances at 400MHz are presented in Figure 11 and Figure 12: the antenna achieves a UHF peak gain of 3.8dBi and edge gain of -0.7dBi. The axial ratio is below 3dB within the full coverage. The performances in the UHF band are not significantly impacted by the presence of the L-band patch.

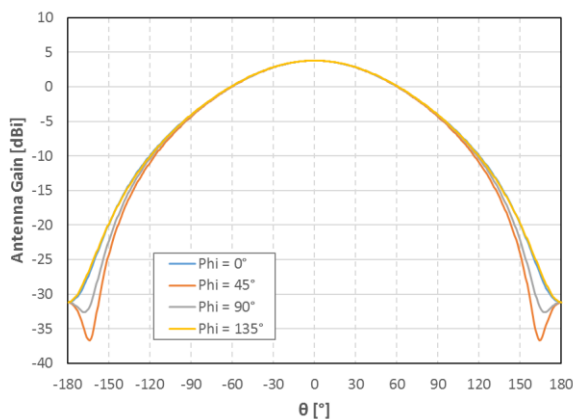

Figure 11 : Integrated Antenna Gain Performances at 400MHz

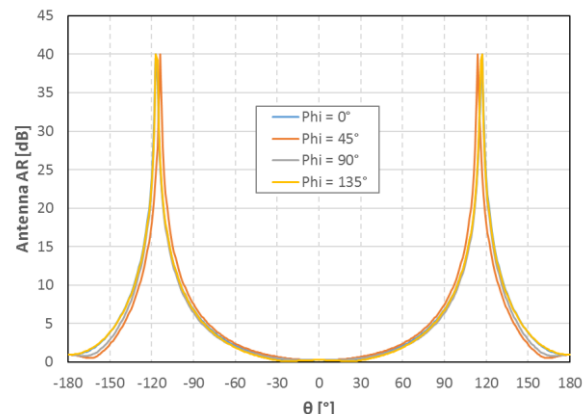

Figure 12 : Integrated Antenna AR Performances at 400MHz

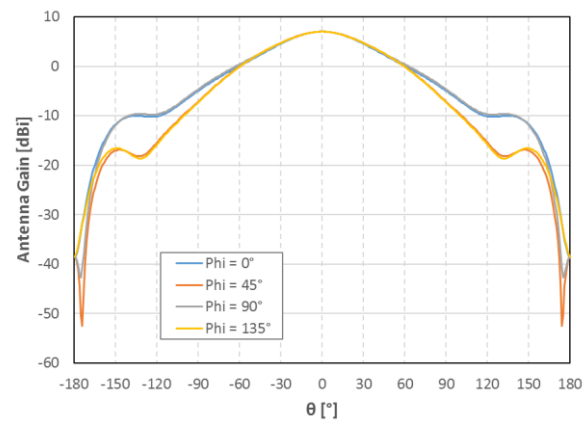

Figure 13 : Integrated Antenna Gain Performances at 1700MHz

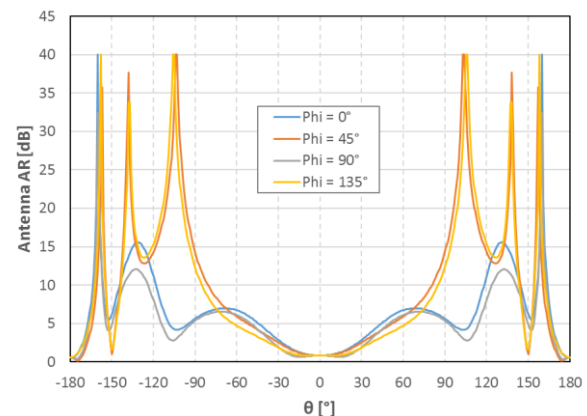

Figure 14 : Integrated Antenna AR Performances at 1700MHz

The RF performances at 1700MHz are presented in Figure 13 and Figure 14: the antenna achieves a L-band peak gain of 7dBi and edge gain of -1.3dBi. The axial ratio is below 7dB within the full coverage. The performances in the L band are strongly impacted by the presence of the UHF antenna.

Spacecraft-level analysis

Due to the strong miniaturization of the antenna at 400MHz, it has been shown that its operating bandwidth is very narrow and sensitive to the antenna environment.

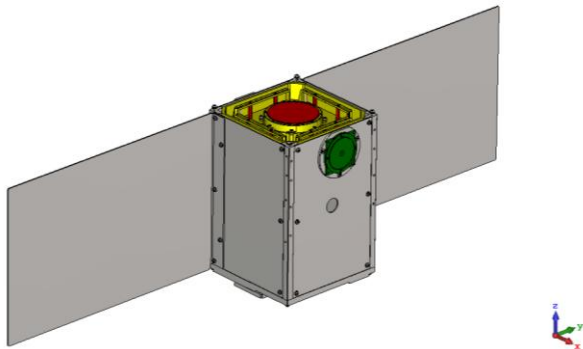

Figure 15 : Antenna on a 12U Spacecraft

The antenna has been simulated on a 12U spacecraft model made of Perfect Electric Conductor (PEC) and two effects are noted. First, the resonance frequency is shifted in all IFA elements: due to the asymmetry of the spacecraft model caused by the solar panels, the shift is different for each IFA and the individual tuning capacitive gaps are used to align all 4 IFA resonance frequencies. Then, a strong distortion of the AR and gain patterns is observed, in particular for θ angles above 60° : as it is shown on Figure 16, the maximum gain is reduced to 1.45 dBi and the minimum edge gain is reduced to -3.6 dBi. Although the mean gain value over the coverage has not significantly changed, the asymmetries of the pattern create low minimum gain values. As shown in Figure 17, high AR values are also observed at the edge of the coverage.

Different solutions have been proposed to improve the performances of the antenna integrated on the spacecraft: in particular, by elevating the antenna above the solar panels, or by deploying a metallic ground plane.

CONCLUSION

In this paper we have presented a miniaturized collocated antenna optimized for a 12U nanosatellite Argos project: ANGELS. This concept allows for a UHF and L-band connectivity using capacitively-loaded IFA radiating elements in a square array to generate circular polarization at 400MHz, and a dual stacked patch providing circular polarization at 1.7GHz. The two collocated antennas were designed and simulated with CST Microwave Studio software as a single antenna system, featuring a tuning capacity to optimize the antenna performances on the spacecraft. The antenna was designed with space qualified materials

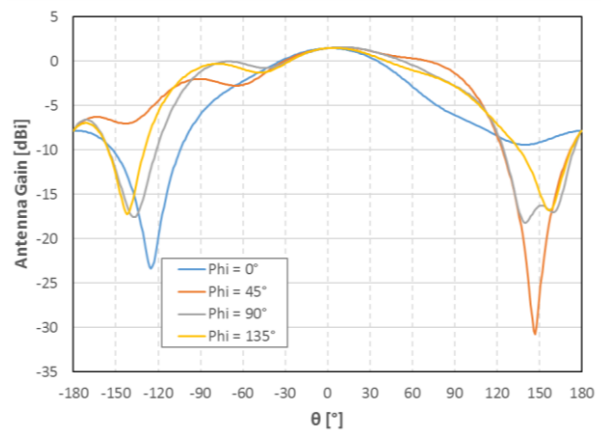

Figure 16 : Integrated Antenna on 12U spacecraft Gain Performances at 400MHz

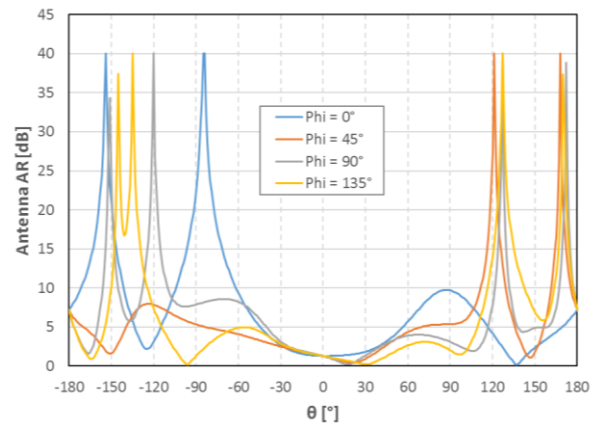

Figure 17 : Integrated Antenna on 12U spacecraft AR Performances at 400MHz

and will be integrated in the ANGELS spacecraft payload.

REFERENCES

1. T. Cussac, P. Jay, D. Delacroix, R. Fragner, L. Javanaud, E. Dequeker and A. Petcu, "ANGELS, an innovative development and contribution to the Argos system as a precursor of a new nanosatellites product line", The 4S Symp. 2018
2. J. Huang, "A technique for an array to generate circular polarization with linearly polarized elements," IEEE Trans. Antennas Propag., vol. 34, no. 9, pp. 1113–1124, Sept. 1986
3. S. Liao and Q. Xue, "Compact UHF Three-Element Sequential Rotation Array Antenna for Satcom Applications", IEEE Trans. Antennas Propag., vol. 65, no. 5, May 2017
4. C. R. Rowell and R. D. Murch, "A Capacitively Loaded PIFA for Compact Mobile Telephone Handsets", IEEE Trans. Antennas Propag., vol. 45, no. 5, May 1997