

The Orbital Calibration 2 (OrCa2) CubeSat Mission

Brian C. Gunter, Alaric Gregoire
Georgia Institute of Technology
620 Cherry St. NW, Atlanta, GA 30332-0150; (404) 385-2345
brian.gunter@aerospace.gatech.edu

Greg Badura, Christopher Valenta
Georgia Tech Research Institute

ABSTRACT

The Georgia Institute of Technology (Georgia Tech), in collaboration with the Georgia Tech Research Institute (GTRI), has developed the Orbital Calibration 2 (OrCa2) mission in an effort to improve space domain awareness. OrCa2's external panels have precise and well-characterized reflective properties that will permit various calibration activities from ground-based optical sensors, with the goal of improving the tracking and detection of resident space objects (RSOs). OrCa2 is a 12U CubeSat designed, fabricated, assembled, and tested almost entirely in-house using GT/GTRI facilities. It will be regularly observed using Georgia Tech's Space Object Research Telescope (GT-SORT). A number of experiments can be conducted with these measurements, such as pose estimation, validation of RSO trajectory propagations with complementary ground-based laser ranging data, multi-spectral analysis, low-light detection algorithms, and validation of atmospheric scattering models. An onboard imager will serve as both a low-accuracy star camera, as well as an on-orbit optical tracking system capable of RSO streak detection, with a mission goal of gathering simultaneous ground-based and space-borne tracking data of one or more RSOs. Additionally, the OrCa2 spacecraft will host an experimental radiation dosimeter, an experimental software defined radio (SDR) receiver, and an experimental power system. OrCa2 is currently manifested to launch in Q1 2024. An overview of the design, concept of operations, and expected outcomes of the mission will be presented.

INTRODUCTION

Background

When observing Resident Space Objects (RSOs) from ground-based optical telescopes, the physical properties of the RSO are often unknown, or only partially known. This includes information such as the pose or material composition of the RSO. This makes it challenging to separate artifacts such as inaccurate modeling of atmospheric refraction from the unknown physical properties of the target RSO. This was the primary motivation behind the original Orbital Calibration (OrCa1)

mission, launched in Q2 2020. This initial mission was a purely passive satellite – designed, built, qualified, and delivered in just six weeks -- with the exterior side panels consisting of well-characterized reflective panels that were designed to permit comparison of observed and “true” reflectance spectrums for calibration of a high-fidelity atmospheric reflectance model currently being developed at GTRI⁶. Unfortunately, after deployment, the OrCa1 spacecraft was never subsequently tracked, so no data has been gathered on OrCa1 to date. While OrCa1 may still ultimately be tracked, this paper describes the follow-on

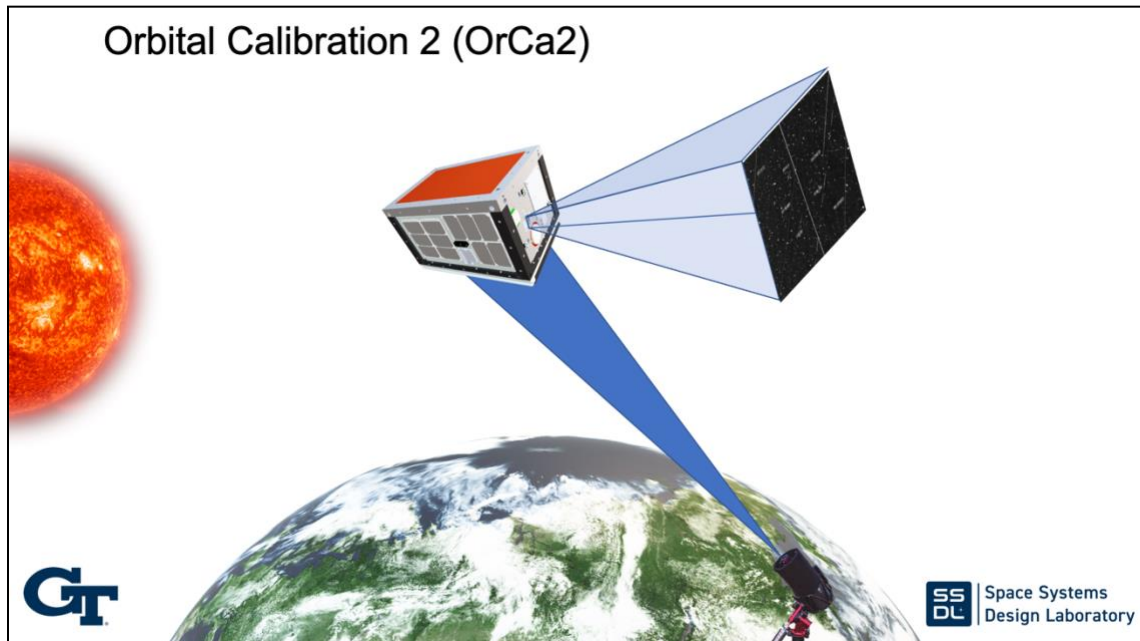

Figure 1: OrCa2 Concept of Operations

effort, the Orbital Calibration 2 (OrCa2) mission.

OrCa2 inherited many of the same key design features of OrCa1, e.g., it is a 12U CubeSat with reflective panels covering much of the exterior, but also introduces a number of key enhancements, such as the inclusion of a full suite of active electronics. Its core mission objectives are still focused on the improvement of space domain awareness through the development of improved tracking capabilities and numerical modeling. OrCa2 is currently manifested to launch in Q1 2024.

Mission Objectives and Overview

The OrCa2’s primary mission objectives are:

- 1) Provide a well-characterized orbiting target for ground-based optical measurement calibration
- 2) Gather on-orbit optical measurements for assessment of space-based, or hybrid (ground and space-based), tracking methodologies
- 3) Gain flight heritage on various experimental sensor and small-satellite technologies

The Concept of Operations (ConOps) for OrCa2 (Figure 1) is relatively straightforward. After deployment on orbit, the spacecraft will detumble and settle into a nominal Sun-tracking orientation. The current insertion orbit for OrCa2 is a “dawn-dusk” sun-synchronous orbit (SSO), that will allow the panel with the solar cells mounted on it to continually point at the sun for uninterrupted power generation. Rotation of the spacecraft about this sun-pointing vector will permit transmission of data to ground stations during scheduled passes, or to point the imagers to dark-sky locations. It will also allow for different viewing geometries of the reflective panels from the ground-based sensors.

SPACECRAFT DESIGN

Structure

The OrCa2 structure follows a 12U CubeSat standard, and closely follows the earlier design of OrCa1 (Figure 2). It is designed to fit within a Rocket Lab/Planetary Systems Corporation

Canisterized Satellite Dispenser (CSD)*. The CSDs require a pair of tab rails that run the length of the spacecraft, but this same feature allows for subsequent design freedom for the rest of the structure. Figure 3 shows the exterior layout of the spacecraft, with the major externally-mounted components labeled. To maximize the number and variety of reflective panels that could be installed, only two of the six panels of the spacecraft contain external components such as antennas, solar panels, lenses, etc. The sun-pointing panel has mostly solar cells, in addition to a fine sun-sensor and an experimental radiation sensor. An end-panel hosts the imagers, communication antennas, GPS antenna, and power inhibit switches.



Figure 2: OrCa1

The reflective panels are a high-density polyethylene material manufactured by Labsphere† that have exacting spectral properties and near-ideal Lambertian reflectance (99% diffusion). More information on the spectral characteristics of the Labsphere Spectralon panels will be provided later.

The edge rails of the external structure are hard-anodized using Anoplate’s proprietary Anoblack EC finish‡, to provide minimal additional reflectance that might interfere with

the Spectralon panel reflectance. In addition, each panel has four corner-cube retroreflectors with an anti-reflective coating meant to isolate the 532 nm and 1064 nm spectral bands and improve the opportunity for ground-based laser ranging observations.

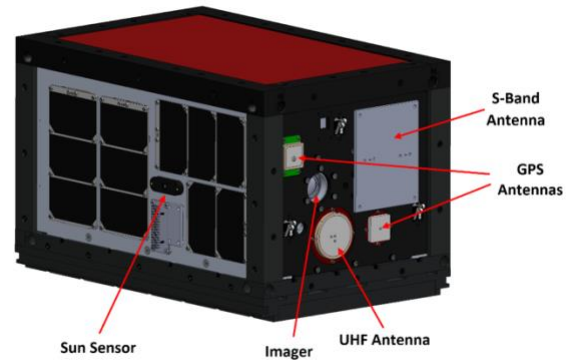

Figure 3: OrCa2 External Components

The internal structure consists of a series of internal plates that provide attachment points for the edge rails and external components, but also provide a shielded compartment for the avionics and payload electronics (Figure 4). Originally, OrCa2 was slated to deploy into a Geosynchronous Transfer Orbit (GTO), so a 1 cm thick shielding box was developed to provide the non-radiation-hardened electronics some protection against the high radiation levels in that orbit. When the orbit was changed to be an SSO, the structure was not modified, as the electronics compartment provides a convenient method for integration. All electronics can be tested and integrated outside of the structure, and then the entire electronics stack can be inserted into the main structure, with only a few harnessing connections to make. The interior structure also allowed for easy incorporation of air-coil magnetorquers, which require large surface area, and the strategic location of the

*<https://www.rocketlabusa.com>

† <https://www.labsphere.com/>

‡ <https://www.anoplate.com/>

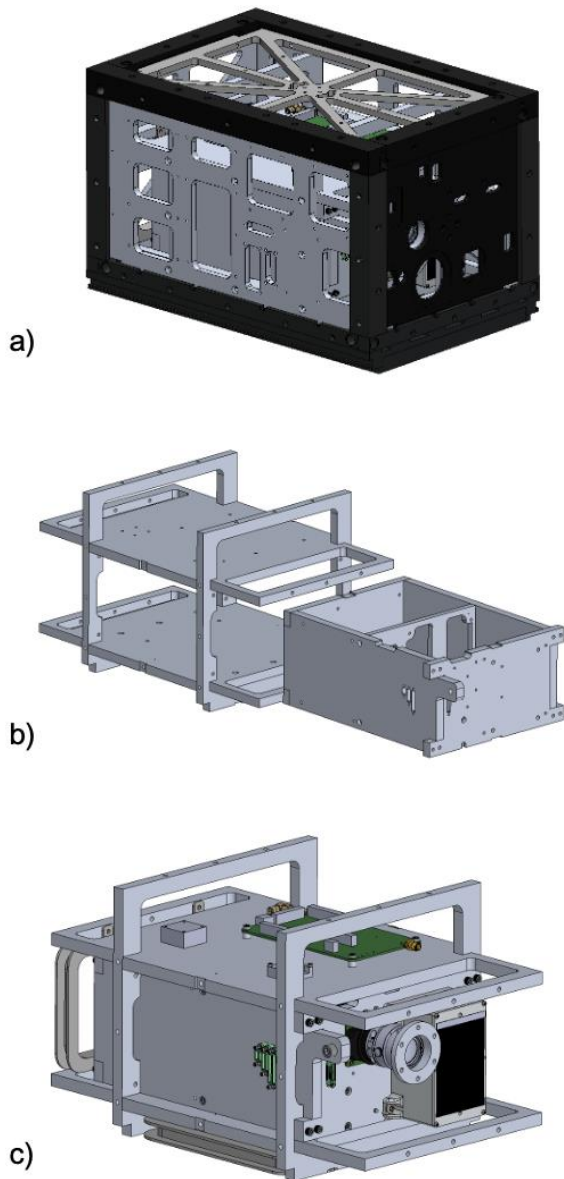

Figure 4: OrCa2 Internal Structure

magnetometer to allow for the least degree of interference from the electronics stack, i.e., outside the shielding box.

All design and machining of the internal and external structural components was done in-house by students and technicians at the Georgia Tech Aerospace Machine Shop.

Bus Electronics

Unlike OrCa1, which was a fully passive satellite, OrCa2 has a complete set of avionics to support the imaging payloads, as shown in Figure 5. This includes a primary electrical power system (EPS) with a 100 Whr battery pack, a Gomspace p31 power distribution board, and an on-board computing (OBC) system driven by a BeagleBone Black running a KubOS operating system.

Attitude control is managed through three air-coil magnetometers and a single CubeSpace CubeWheel reaction wheel. Attitude knowledge will be determined from a SolarMEMs fine sun sensor, a 3-axis magnetometer, and an EPSON G370 inertial measurement unit (IMU). Sub-arcsecond attitude knowledge will also be possible through post-processing of the images taken from the imager. Positioning data will be provided through an on-board L1 GPS receiver.

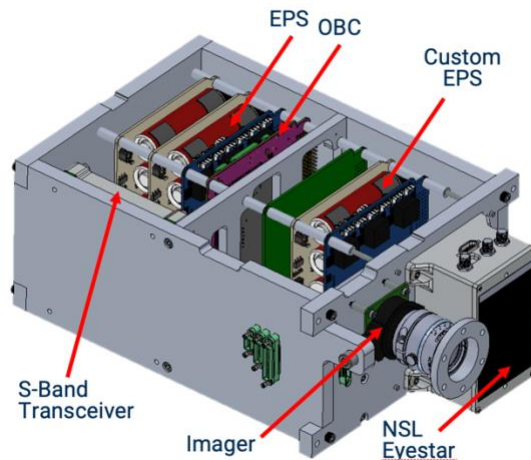

Figure 5: Internal Electronics

Communications

OrCa2 will have two communications systems. The first is an Eystar S4 system developed by NearSpace Launch, Inc. This system utilizes the Iridium satellite network to transmit and receive low-rate data packets. This provides

nearly continuous communication coverage, and will serve to transmit housekeeping and positioning information throughout the mission lifetime.

The Eystar system is not intended for high-volume data transfers, so a separate S-band communication system will be included to downlink data from the imagers and other large data sets, e.g., raw GPS data, raw IQ data, IMU time series data, etc. Bulk housekeeping downloads and software updates will also be managed through the S-band system.

Payloads

The primary payloads for OrCa2 include the imager and the reflective panels. The imager is a commercially available Hi-Q camera, originally developed for the Raspberry Pi community. This is a 12 megapixel, visible-spectrum detector, that will be paired with a space-rated Schneider Citrine lens that has heritage on prior CubeSat missions^{3,4}.

The imager will have two objectives. The first will be to provide accurate attitude knowledge. This will help maintain low errors on the drift estimates of the IMU, and ensure that the orientation of the spacecraft is well-known for observation campaigns with the ground-based telescopes. In this sense, the imager will serve as a low-cost star camera, and experiments will be conducted to perform the astrometry in real-time, on-board the spacecraft OBC. This will in-turn be validated through more robust processing from the downlinked raw images. Expected attitude knowledge from the imager based on preliminary testing is at the sub-arcsecond level, and has already been demonstrated at the bench-top level using the same processor that will fly on-orbit. An example of the processing taken from a ground-based image taken of the night sky from the Georgia Tech is shown in Figure 6.

The second objective of the imager is to observe other RSOs. By stacking images and

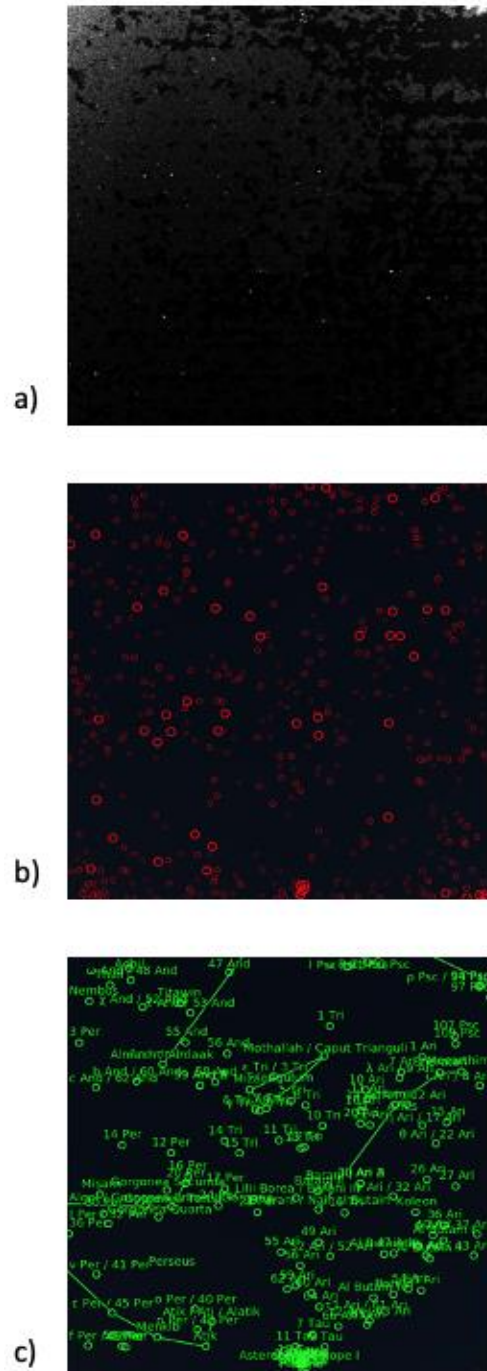

Figure 6: Astrometry example showing transition from a) the raw image, to b) the source extraction to c) the final solved image

performing streak detection, the orbits of visible RSOs should be possible. This creates the opportunity for a host of experiments involving the accuracy of orbit predictions

from satellite-only observations, as well as potential simultaneous observations from both ground and space-based imagers. The improved geometric diversity from such RSO measurements could make orbit predictions more accurate, and provide new opportunities for future monitoring networks¹

The other primary payload on OrCa2 is the reflective panels that will cover four of the six sides of the spacecraft. As mentioned earlier, these are highly diffusive reflective panels that have stable and well-characterized reflectance properties, as shown in Figure 7. Three panel colors were chosen to provide distinct reflectance patterns when observed from the ground: Orange, Red, and Blue. The fourth panel is Labsphere’s Spectralon material, which provides near-uniform high reflectance across all visible wavelengths.

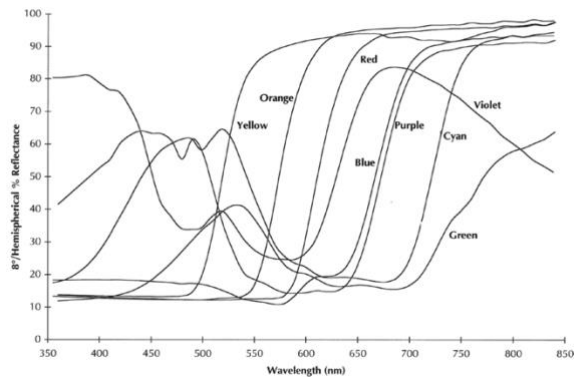

Figure 7: Representative reflectance of the Labsphere panels⁵.

The intent is to observe OrCa2 from a ground-based telescope, using various lens filters, e.g., Johnson-Cousins, so that the total reflected energy from the image can be assigned to various panels. This should permit the determination of the orientation of OrCa2 from only spectral information, which can in turn be validated using data from the on-board IMU.

Knowing what the true reflected energy should be, and comparing this to the actual observed reflectance, will also provide valuable insight

into the atmospheric refraction along the light travel path.

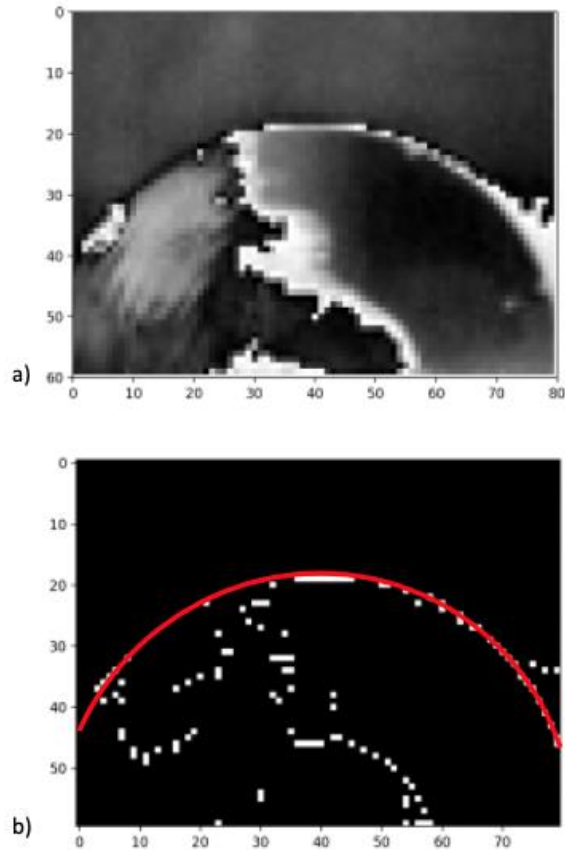

Figure 8: a) raw image and b) horizon detection from the TIR sensor

Secondary Payloads

Several other secondary payloads will also be flown on OrCa2 as a series of technology demonstrations. This includes an open-source, open-hardware software defined radio (SDR), a custom EPS system, a thermal infrared (TIR) detector, and a radiation sensor. The hope is to gain flight heritage and to raise the technology readiness level (TRL) on these components, with an eye towards flying them on future CubeSat missions. For example, the custom EPS system would allow future small-satellite projects to have full control and design flexibility of the power management system. The TIR sensor could be used as a future fine Sun sensor or horizon sensor, as shown in Figure 8. This figure shows a sample heated

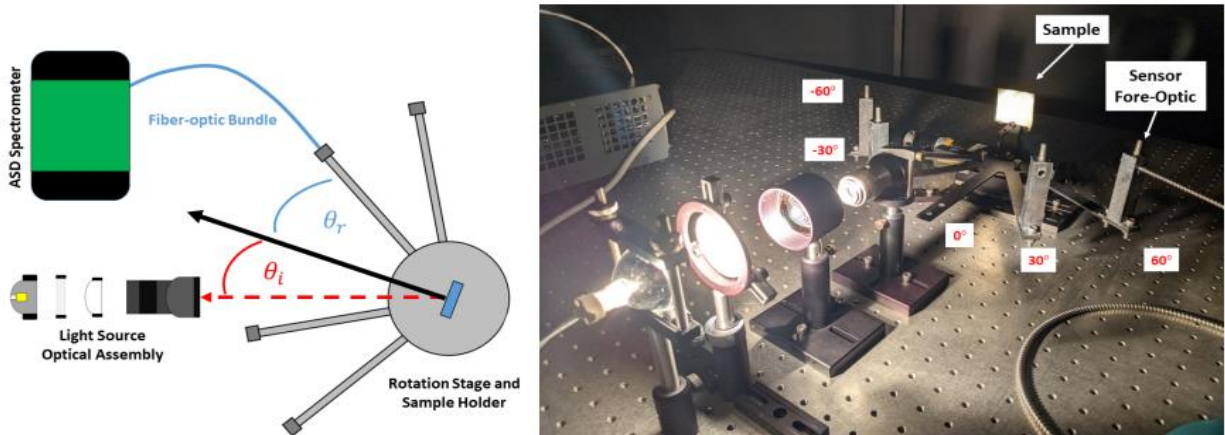

Figure 9: The goniometer system used in this study when measuring a sample. (Left) A diagram showing the main components of the system and the conventions for the viewing orientation and illumination orientation. (Right) A figure of the system when measuring a sample with the location of the fiber optic at the $\theta_r = +60^\circ$ location, and the fiber optic holder slots labeled by θ_r value

circular plate that is designed to represent Earth’s horizon from orbit. Edge finding algorithms are then used to determine the horizon.

BRDF Characterization

Performing unmixing of RSO material composition via spectrometry requires knowledge of the constituent material’s directional reflectance characteristics and knowledge of how these directional signatures will mix within a telescope’s filter bandpass. In order to perform such unmixing, the material’s Bidirectional Reflectance Distribution Function (BRDF) must be precisely characterized on the ground prior to mission launch.

Towards this end, we have designed a principal plane goniometer system (Figure 9) that is responsive to spectral radiance over the spectral range of 400 to 2400 nm using commercial off-the-shelf (COTS) components. We have also developed a method for acquiring spectral BRDF (sBRDF) measurements using the system that are fully derived in [7].

GTRI will utilize physically validated laboratory space weather aging approaches on the materials prior to performing sBRDF measurements. GTRI has experience in performing both laboratory and in-situ low Earth Orbit (LEO) aging of materials onboard the International Space Station (ISS) that will be leveraged in OrCa2 calibration experiments⁸. These experiments will provide an understanding of how sBRDF changes over time in orbit in response to different components of the space environment, which our research has shown will be critical due to the change in BRDF that occurs due to space weathering.

This system and post-processing scheme will be utilized to derive an empirical dataset of the BRDF measurements of the materials onboard OrCa2. The empirical sBRDF signatures will ultimately be fitted to theoretical sBRDF models and ingested by advanced radiometric simulation tools for simulating OrCa2 light curves via pipelines that are presented in [6,7]. This dataset will provide a ground truth database of signature vs. pose information that can be used for training and validation of



Figure 10: The Georgia Tech Space Object Research Telescope (GT-SORT)

algorithms for tasks such as pose estimation and material unmixing.

GT-SORT

GT-SORT is a Raven-class telescope equipped with both a finder scope and sub-degree field-of-view (FOV) main scope². The main scope is capable of switching between the five Johnson's Cousin UBVRcIc astronomy filters. The apparent magnitudes of OrCa2 will be collected through photometric processing of collected images and combining observations of standard stars enables the calculation of absolute magnitudes. Absolute magnitudes are independent of weather conditions and therefore is valuable as a calibration standard.

With a ten-degree elevation mask, the predicted visibility of OrCa2 is seasonally dependent. Most viewing opportunities occur between the months of October and April, as the precession of high-inclination orbits shifts OrCa2 out of view from Atlanta during the summer. The average ground pass duration is approximately 6 minutes in duration, so testing

of the ground station automation will be essential.

Acknowledgments

The OrCa2 mission was supported in part from Georgia Tech Research Institute (GTRI) Independent Research And Development (IRAD) funds, the Aerospace Corporation, and the Georgia Tech School of Aerospace Engineering. Computational results were supported in part through research cyberinfrastructure resources and services provided by the Partnership for an Advanced Computing Environment (PACE) at the Georgia Institute of Technology, Atlanta, Georgia, USA. Launch and integration services for OrCa2 are being provided by Parsons Corporation, and the U.S. Space Force's Mission Manifest Office.

References

1. Gregoire, A., Gunter, B.C., Badura, G., Valenta, C., "Utilizing Space-Based Observers to Expand Optical Space Surveillance Detection Capabilities," Paper AAS 22-753, 2022 AAS/AIAA

- Astrodynamics Specialist Conference, Charlotte, NC, Aug. 7-11, 2022.
2. Coder, R., Jaunzemis, A., Mathew, M., Worthy, J., and Holzinger, M., "Georgia tech space object research telescope." *Journal of Spacecraft and Rockets* 54:6 (2017): 1399-1403.
 3. McIntosh, D., Baker, J., Matus, J., "The NASA Cubesat Missions Flying on Artemis-1," SSC20-WKVII-02, 34th AIAA Small Satellite Conference, Logan, UT, August 2020.
 4. Pack, D., Ardila, D., Herman, E., Rowen, D., Welle, R., Wiktorowicz, S., Hattersley, B., "Two Aerospace Corporation CubeSat Remote Sensing Imagers: CUMULOS and R3," SSC17-III-05, 31st AIAA Small Satellite Conference, Logan, UT, August 2017.
 5. Labsphere, Inc. "Spectralon Diffuse Color Standards Data Sheet", 2021.
 6. Hope, D., Birch, M., Cordell, C., Prussing, K., Valenta, C., "Dynamic Model Integration and Simulation Engine- (DMISE-) assisted design of future sensor networks in support of Space Traffic Management," *Advanced Maui Optical and Space Surveillance Technologies Conference (AMOS)*, 2021.
 7. Badura, Gregory, Elena Plis, and C. Valenta. "Extending Laboratory BRDF Measurements towards Radiometric Modeling of Resident Space Object Spectral Signature Mixing." In *Advanced Maui Optical and Space Surveillance Technologies Conference (AMOS)*. 2021.
 8. Plis, Elena A., Miles T. Bengtson, Daniel P. Engelhart, Gregory P. Badura, Heather M. Cowardin, Jacqueline A. Reyes, Ryan C. Hoffmann et al. "Ground Testing of the 16th Materials International Space Station Experiment Materials." *Journal of Spacecraft and Rockets* (2023): 1-6.