

7-2-2008

Multi Path FTIR Agriculture Air Pollution Measurement System

Cassi Going

Gail Bingham

Nikita S. Pougatchev

Eve Day

Kori Moore

Randal Martin

See next page for additional authors

Follow this and additional works at: https://digitalcommons.usu.edu/sdl_pubs

Recommended Citation

Going, Cassi; Bingham, Gail; Pougatchev, Nikita S.; Day, Eve; Moore, Kori; Martin, Randal; and Reese, Emyrei, "Multi Path FTIR Agriculture Air Pollution Measurement System" (2008). *Space Dynamics Lab Publications*. Paper 53.
https://digitalcommons.usu.edu/sdl_pubs/53

This Article is brought to you for free and open access by the Space Dynamics Lab at DigitalCommons@USU. It has been accepted for inclusion in Space Dynamics Lab Publications by an authorized administrator of DigitalCommons@USU. For more information, please contact dylan.burns@usu.edu.



Authors

Cassi Going, Gail Bingham, Nikita S. Pougatchev, Eve Day, Kori Moore, Randal Martin, and Emyrei Reese



2950 Niles Road, St. Joseph, MI 49085-9659, USA
269.429.0300 fax 269.429.3852 hq@asabe.org www.asabe.org

An ASABE Meeting Presentation

Paper Number: 084080

Multi Path FTIR Agriculture Air Pollution Measurement System

Cassi Going

Space Dynamics Laboratory, cassi.going@sdl.usu.edu

Gail Bingham, Ph.D.

Space Dynamics Laboratory, gail.bingham@sdl.usu.edu

Nikita S. Pougatchev, Ph.D.

Space Dynamics Laboratory, nikita.pougatchev@sdl.usu.edu

Eve Day

Space Dynamics Laboratory, eve.day@sdl.usu.edu

Kori Moore

Space Dynamics Laboratory, kori.moore@sdl.usu.edu

Randal Martin, Ph.D.

Utah State University - Civil & Environmental Engineering Dept., rmartin@cc.usu.edu

Emyrei Reese

Utah State University - Civil & Environmental Engineering Dept., emr@cc.usu.edu

**Written for presentation at the
2008 ASABE Annual International Meeting
Sponsored by ASABE
Rhode Island Convention Center
Providence, Rhode Island
June 29 – July 2, 2008**

The authors are solely responsible for the content of this technical presentation. The technical presentation does not necessarily reflect the official position of the American Society of Agricultural and Biological Engineers (ASABE), and its printing and distribution does not constitute an endorsement of views which may be expressed. Technical presentations are not subject to the formal peer review process by ASABE editorial committees; therefore, they are not to be presented as refereed publications. Citation of this work should state that it is from an ASABE meeting paper. EXAMPLE: Author's Last Name, Initials. 2008. Title of Presentation. ASABE Paper No. 08----. St. Joseph, Mich.: ASABE. For information about securing permission to reprint or reproduce a technical presentation, please contact ASABE at rutter@asabe.org or 269-429-0300 (2950 Niles Road, St. Joseph, MI 49085-9659 USA).

Abstract. *This paper details the design and validation of a Multiple Path OP-FTIR system with elevation and radial scanning ability and demonstrates its capabilities to quantify and monitor gaseous ammonia emitted from agricultural facilities.*

The OP-FTIR system has a 500 m range (1000 m full path length) and allows 360° radial scan and 45° scan in elevation. To study large scale sources, two or more similar systems may be needed. For comparison purposes, we ran two similar but not identical OP-FTIR systems side-by-side in a controlled lab environment and in a series of field environments.

We determined that in a controlled environment, the two systems can attain an NH₃ agreement of 1-3% at concentrations above 500 ppb. Due to the short path length (~10 m) in the lab, 500 ppb was the detection limit of the two systems. Path lengths in a field are much longer, allowing a lower detection limit. Average agreement in the field was 1-6%. This difference in agreement from the laboratory is likely due to the non-homogeneous distribution of the pollutant.

Keywords. OP-FTIR, Spectroscopy, Agriculture pollution, Ammonia, PM2.5

Introduction

Recently, regulatory agencies such as the EPA have focused on estimating agricultural source emissions. Agricultural sources produce a complex and highly variable pollutant distribution, including many potentially harmful air pollutants, such as ammonia (NH_3), hydrogen sulfide (H_2S), methane (CH_4), various volatile organic carbon (VOC) compounds, and particulate matter (PM). Open-path Fourier transform infrared spectroscopy (OP-FTIR) is a versatile technology that allows multiple pollutants to be measured simultaneously at concentrations of low parts per billion (ppbv), making it a useful measurement tool for agricultural sources.

Gaseous ammonia, the specific gas targeted during this study, is a common by-product of animal waste (Arogo, 2006). The EPA (2004) estimates that in the year 2000, agriculture-related activities accounted for ~90% of total anthropogenic ammonia emissions in the United States with ~73% of this from agricultural livestock.

Ammonia is an important precursor of fine particle matter, also known as $\text{PM}_{2.5}$. Ammonia forms $\text{PM}_{2.5}$ as it reacts with sulfur dioxide (SO_2) and nitrogen oxides (NO_x) in the atmosphere to create ammonium nitrate (NH_4NO_3) and ammonium sulfate ($(\text{NH}_4)_2\text{SO}_4$). $\text{PM}_{2.5}$ can add substantially to haze and visibility problems and, due to its small size, can also penetrate deep into the lungs, creating health risks for those exposed (Battye, 2003). Ambient ammonia concentrations in the atmosphere range from < 1 parts per billion (ppb) in remote areas to > 50 ppb downwind of agricultural sources (Finlayson-Pitts and Pitts, 2000). Therefore, in order to regulate and monitor $\text{PM}_{2.5}$ concentrations, it is important to devise ways, such as the system described herein, to accurately measure and characterize ammonia emissions.

Instrumentation

FTS1

The Fourier Transform Spectrometer (FTS) used in these experiments was originally designed to be set up in a monostatic configuration with a single telescope as both the transmitting and receiving optics (Figure 1). Using an active IR source, a beam is transmitted through a Bomem double pendulum interferometer and other transmitting optics. The modified beam then passes through a medium that may contain the target pollutant, represented by the cloud in Figure 1. A retroreflector sends the beam back through the medium and then through the receiving optics to a sterling cycle cooled MCT detector, producing an interferogram (Smith, 1996). The interferogram is manipulated by software and fit to a spectral library to identify and quantify the pollutant (Shao, 2007).

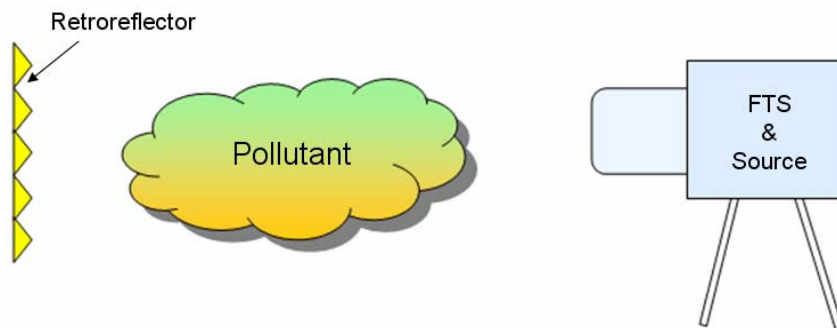

Figure 1 - Monostatic FTS setup.

For larger, more variable sources, it may be desirable to set up multiple reflectors at different heights and positions around the source in order to locate hot spots and accurately model emissions. To do this, a system was developed around the FTS to facilitate scanning. It was designed to be portable and low cost, and to allow the FTS to remain stationary.

Turret Design

A "turret" was designed to direct the beam to each of the target retroreflectors. It allows 360° scan in azimuth and +30°/-15° scan in elevation (Figure 2). The turret's frame is constructed out of T-slotted aluminum and covered with a composite material, making it lightweight and durable. The beam is deflected off a pointing mirror mounted inside the turret on a goniometric cradle motor used to control elevation angle. The whole turret assembly is mounted on a precision rotation stage used to control azimuth position. A view of the beam's directed path is provided using a camera with a telescopic lens mounted parallel to the beam entrance/exit.

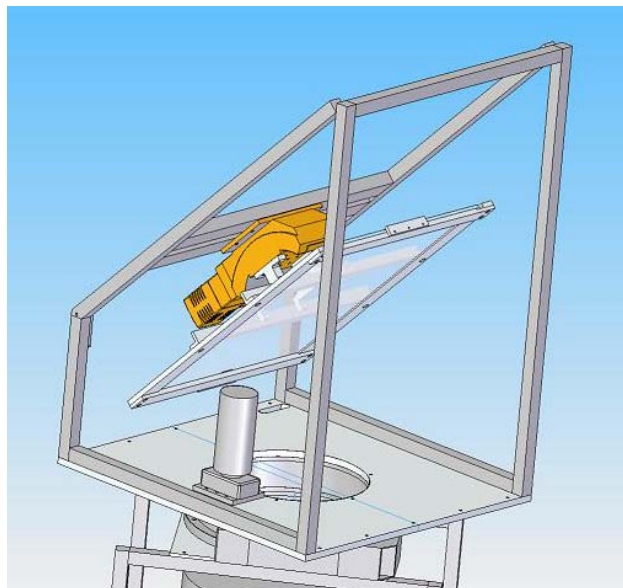

Figure 2 – Turret assembly showing the motion controlling stage and cradle motor.

The rotation stage is connected to a support frame for the instrument. The FTS rests on its side staring up through an 11" hole in the rotation stage and turret and into the mirror. The whole assembly is supported by a simple scaffold (Figure 3) that is anchored to the ground for stability. The system's lightweight and modular design allows it to be easily transported and set up quickly and with minimal manpower.



Figure 3 - Assembled Multipath FTS System.

Control Software

The turret is controlled through a LabView software interface that takes commands from a joystick and interacts with the two motors. The image from the camera is displayed on the computer screen to aid in pointing. Once the beam is aligned with a retroreflector, the motor positions can be locked in and stored for use in a profile. A profile is a set series of measurements, or a scan, composed of the motor positions for alignment with different reflectors located around an emission source. A profile is created and executed in the motion-control software. Once a profile is executed, the turret will then cycle through each of the profile positions. It will point the beam at each of the retroreflectors in turn, pause to take data, and then move to the next position.

The FTS collects data continuously, which causes two problems. First, the data collected while the turret is moving is unusable because there will be no return beam. Second, all the data collected at each position will be stored in one file. Data at different path-lengths cannot be processed together with the same background measurement. To separate the data, the software running the turret creates a file containing a timestamp for each time the turret reaches a position, the time it leaves a position, and the position number. After all the data is collected, this file is used to filter out the data taken during turret movement, distinguish data from each position, and write it to a separate file.

Data Processing Software

After the data is separated, gas-phase ammonia concentrations are calculated using a quantification software package written by Dr. Peter Griffiths and Dr. Limin Shao at the University of Idaho (Shao, 2007). Spectra are calculated from the collected interferograms and fit to a spectral library developed at the National Institute of Standards and Technology (NIST) (Sharpe, 2001).

FTS2

To study large scale systems, two instruments may be needed to accurately model emissions. A second FTS was run alongside the instrument described above in order to determine their comparability. It differs somewhat from FTS1 in that it has a Bomem Michelson interferometer with a liquid nitrogen cooled detector. The two instruments were compared side-by-side on tripods and also with the first FTS (FTS1) set up in the multi-path system.

Ogawa Passive Samplers

In the laboratory and field experiments, 10-20 Ogawa Passive Samplers were set up at equidistant points along the FTS beam path to quantify the time-averaged ammonia concentration. These passive samplers are another method of measuring atmospheric ammonia concentrations and are described in detail by Roadman et al. (2003). A sampler is made of a solid 3 cm long Teflon cylinder with an open cavity at each end. Inside each end of the sampler is a glass-fiber filter, which has been soaked in a 5% citric acid solution, sandwiched between two stainless steel screens and held in place by a Teflon cap.

When deployed, ammonia diffuses into the pores, and a chemical reaction bonds it to the citric acid-coated pad. Before and after sample exposure, the cartridges are sealed in plastic bags and sample bottles and refrigerated to prevent contamination and sample loss. Analyses are performed using ion chromatography with appropriate calibration and calibration checks, using known concentrations of ammonia and blanks. The Ogawa passive samplers can quantify gas-phase ammonia concentrations of less than 1 ppb to 15 parts per million (ppm) through controlling the exposure time. After deployment, a time averaged ammonia concentration is calculated using the diffusion equations presented by Roadman et al. (2003).

Laboratory Experiments

To determine, in a controlled environment, how comparable the two FTS systems were they were set up side-by-side on tripods in a 10-meter tunnel (20 m path length) constructed of polyurethane plastic sheeting over three construction scaffolding sets (Figure 5). Passive ammonia samplers were also spaced at equal intervals next to the beam path. Before starting the experiment, a background measurement was taken with each of the instruments to obtain spectra with no ammonia present. Next a gaseous ammonia source was placed in the tunnel and the concentration was allowed to build to a desired level, as measured by a real-time personal exposure monitor, usually between 10 and 25 (ppm). Afterwards, the source was removed, the tunnel was sealed off, and data were taken as the ammonia concentration slowly reduced as it was deposited on the tunnel walls. Air was circulated inside the tunnel using several fans in order to make the concentration field more uniform. Figure 6a shows the FTS results typical of all tests in the tunnel. Ammonia concentration as measured by each of the instruments is plotted on a log scale versus time. The ratio between concentrations measured by FTS1 and FTS2 as a function of ammonia concentration is also shown (Figure 6b). Throughout this paper, the FTS labeled as the FTS1 is the instrument used in the scaffold and turret system for multiple path scanning. FTS2 is the second instrument used for comparison and characterization of FTS1. The two FTS instruments agreed to within 10-20% until the ammonia concentration decayed to about 0.5 ppm. Because of the short path length, the detection limit for both instruments was reached at this point. When longer path lengths are used, the instruments are capable of measuring ammonia levels below 0.5 ppm.



Figure 5 - Tunnel experiment setup.

Open path instruments measure the total amount of a specific gas in the path between the transmitter and detector. This integrated column data is measured in ppmm (parts per million meters). For example, a concentration of 11.5 ppm over a distance of 10 m (total path to and from the reflector is 20 m) would give a reading of 11.5 ppm * 20 m or 350 ppmm. Similarly, a concentration of 0.5 ppm with a path length of 350 m would also give a reading of 350 ppmm. This means that if at 10 m the detection limit is 0.5 ppm, or 10 ppmm, the detection limit at 350 meters would be 10 ppmm/ 700 m, or 0.0143 ppm (14.3 ppb). If the distance between the instrument and the retroreflectors were 500 meters, the detection limit would be 10 ppmm/ 1000 m or 0.01 ppm (10 ppb). As the path length increases, the detection limit decreases.

The passive samplers deployed along the path reported much higher concentrations than calculated from the two FTS instruments.

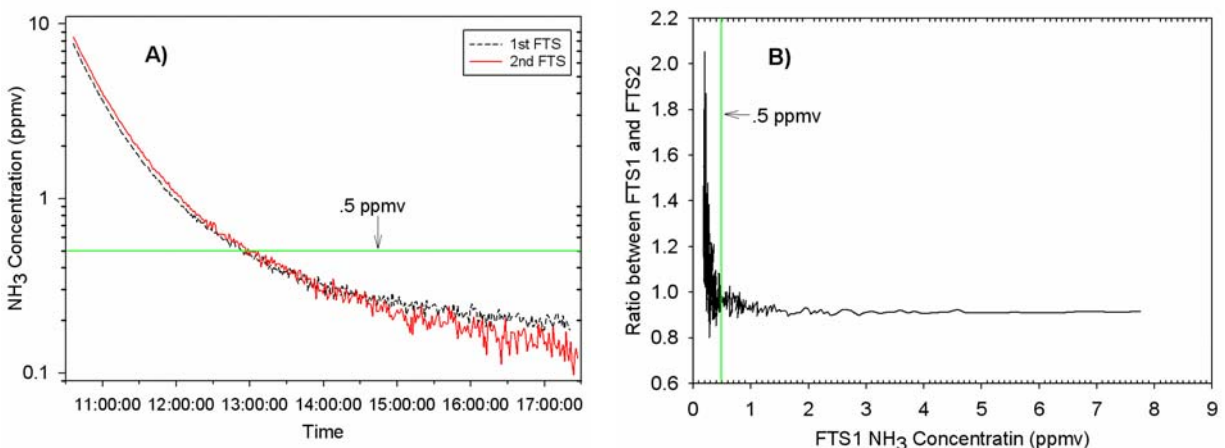

Figure 6 - Typical a) ammonia concentration and b) ratio results for a tunnel run.

Multiple tests were performed using this enclosed tunnel with varying instrument settings to investigate the effect of different settings on the instruments' agreement. Each instrument has five detector gain settings labeled A through E, with A being the lowest gain and E being the

highest. Each incremental gain setting will increase the intensity of the signal by a factor of two. The data previously presented were collected when both instruments were set to gain A. Each combination of settings on the two instruments was tested by releasing 15 ppm of ammonia inside the tunnel and then taking 15 measurements for each pair of settings. Wire mesh was placed over the edge of the telescopes to attenuate the signal at higher gains in order to avoid saturating the detector. Based on these tests, the average ratios of the measured concentrations between the two instruments were calculated and are summarized in Table 1. Figure 7 is a graphical representation of these results. Optimal agreement can be achieved by operating in the blue region (ratios of .95 - 1.02).

Table 1 - Average ratio between instruments for different gain configurations

		FTS2				
		A	B	C	D	E
FTS1	A	0.84	0.94	0.92	0.95	1.02
	B	0.93	0.84	0.90	0.90	1.01
	C	0.87	0.90	0.91	0.86	0.97
	D	0.83	0.84	0.84	0.91	0.92
	E	0.79	0.73	0.78	0.79	0.96

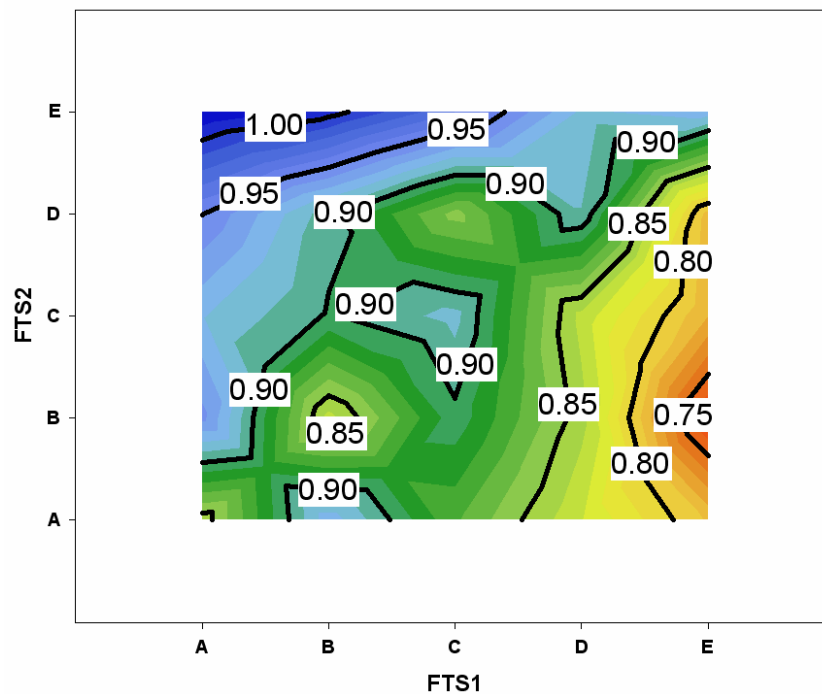

Figure 7 - Map of average ammonia concentration ratios with different gain configurations presented as ratio contours overlaid on the setting configuration grid.

Field Experiments

After completing the laboratory experiments, a series of tests were performed in non-controlled field environments to examine the reproducibility of the tunnel experiment results pertaining to instrumentation agreeability and also to test the multi-path system. Backgrounds for the field measurements were taken in locations with negligible ammonia concentrations at the same path length.

Laying Hen Farm

To test the FTS systems and passive samplers in dynamic field conditions with high ammonia concentrations, they were taken to a laying hen chicken farm located near Logan, Utah with around 750,000 chickens (Woodward, 2007). There are 11 barns with large fans lining one side for ventilation. The instruments were taken to this facility on two separate occasions in two slightly different configurations.

On July 5, 2007 the two FTS instruments were set up side-by-side on tripods pointing between two chicken barns (being exposed to exhaust fans from just one building), and 15 passives were placed at equal intervals along the beam path, 6 m away from the fans (Figure 8a). The retroreflector was placed 103 m away at the far end of the two barns. Gain settings on both FTS instruments were set to B. The FTS systems show ammonia concentrations varying from 2.5 to 4.5 ppm (Figure 8b) with an average of 2.36 ± 1.78 ppm. The concentrations calculated from data collected by each FTS track each other very well throughout most of the sample period. The percent difference between the two FTS systems was on average 6%; however, the average concentration calculated from the passive samplers was much larger than that of the FTS systems (Figure 9).

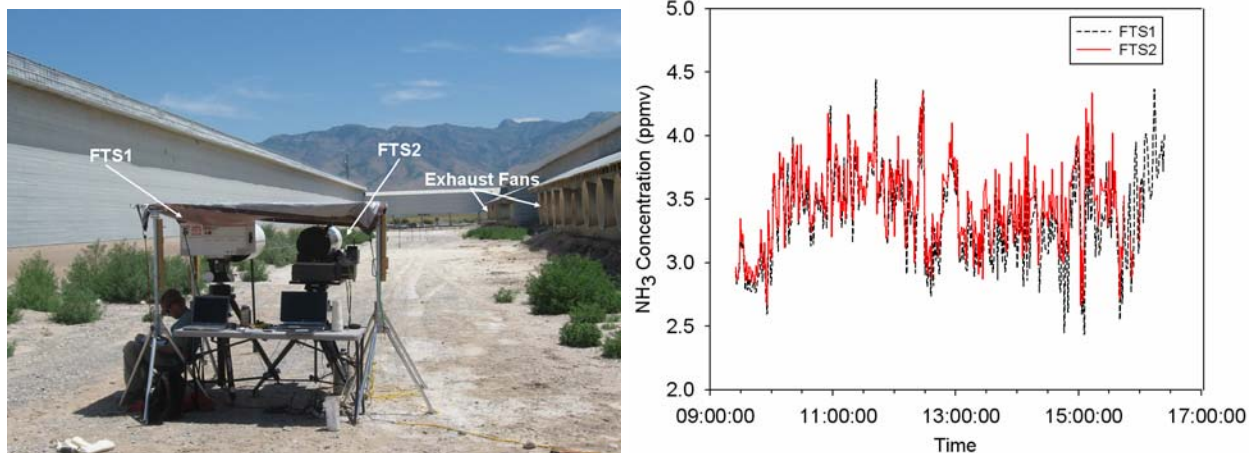

Figure 8 – a) deployed FTS systems and b) FTS ammonia concentration results.

This is possibly due to forced diffusion caused by the ventilation fans, as will be discussed in the following sections. The effects of the two sets of ventilation fans on the side of the barn can clearly be seen in Figure 9 where the passive samplers in front of the two sets of fans report extremely high concentrations of ammonia.

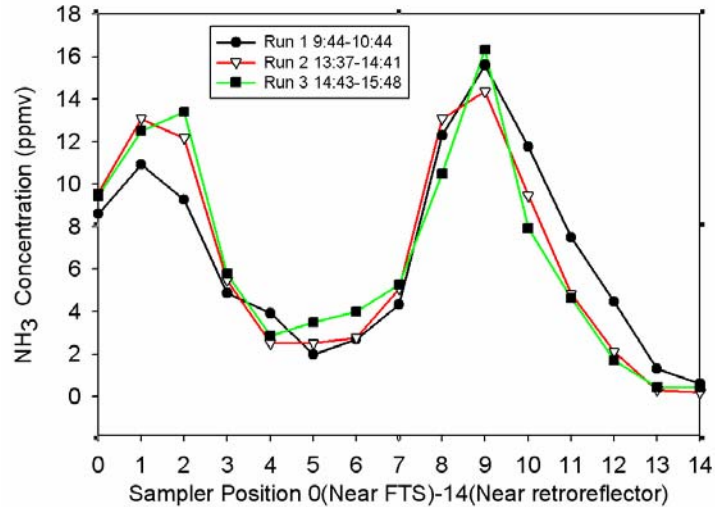

Figure 9 - Time averaged NH₃ concentrations for each passive sampler during three separate hour long runs.

A second test consisting of three hour long sample periods was conducted at the facility on August 22, 2007. FTS1 was placed in the multi-path system, while FTS2 was on a stationary, elevated tripod (Figure 10a). A set of passive samplers were distributed along the path 6 m away from the front of the fans. Five retroreflectors were set up at four different path lengths (44 m, 70.5 m, 103 m, and 250 m) along a straight line, with the two retroreflectors at 250 m mounted on a tower at 2 m and 9 m above ground level (Figure 10b). The first three retroreflectors were distributed along a line between the barns. Another potential ammonia source was a manure compost row located between the barns and the tower and oriented perpendicular to the beam.

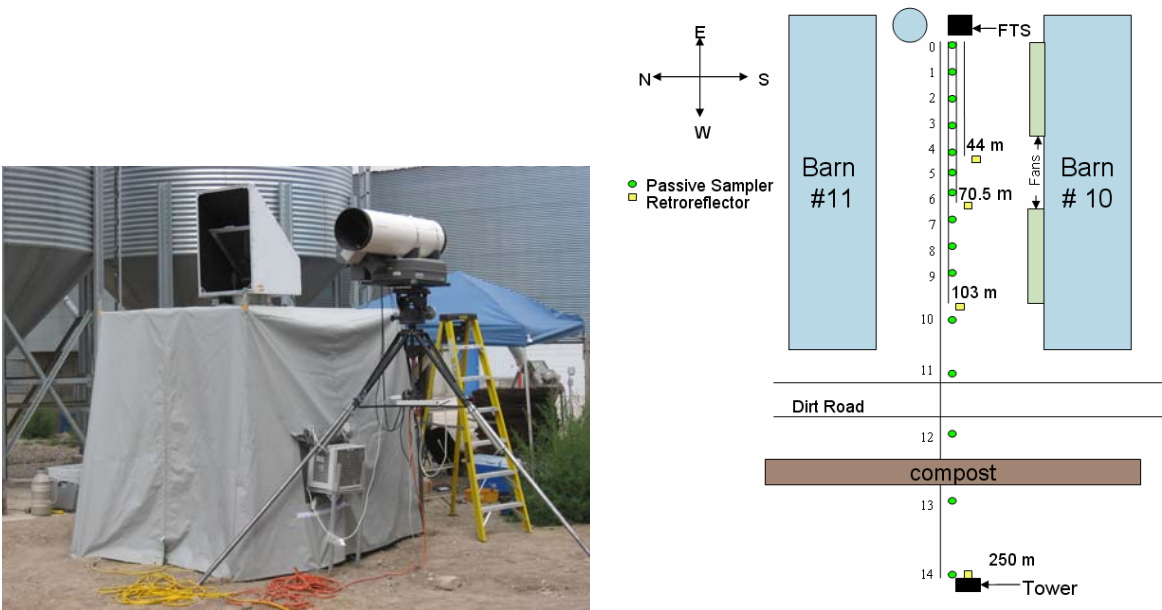

Figure 10 - a) August 21-22 FTS Setup and b) site layout.

When data were being collected, FTS2 was set to stare at the retro reflector 103 m away while FTS1 scanned and collected data at each of the five reflectors for four minutes during each scan. Tests did not show additive effects to either instrument's beam when both were using the same retroreflector. Gain settings on the FTS instruments were set to obtain maximum agreement (FTS1 was set to B and FTS2 was set to E). For times when the scanning FTS was taking data at the 103 m reflector, the percent difference between the two systems was within 1% (Figure 11a). The path integrated average ammonia concentrations collected from the scans of the multi-path FTS are shown in Figure 11b for each of the three sample periods.

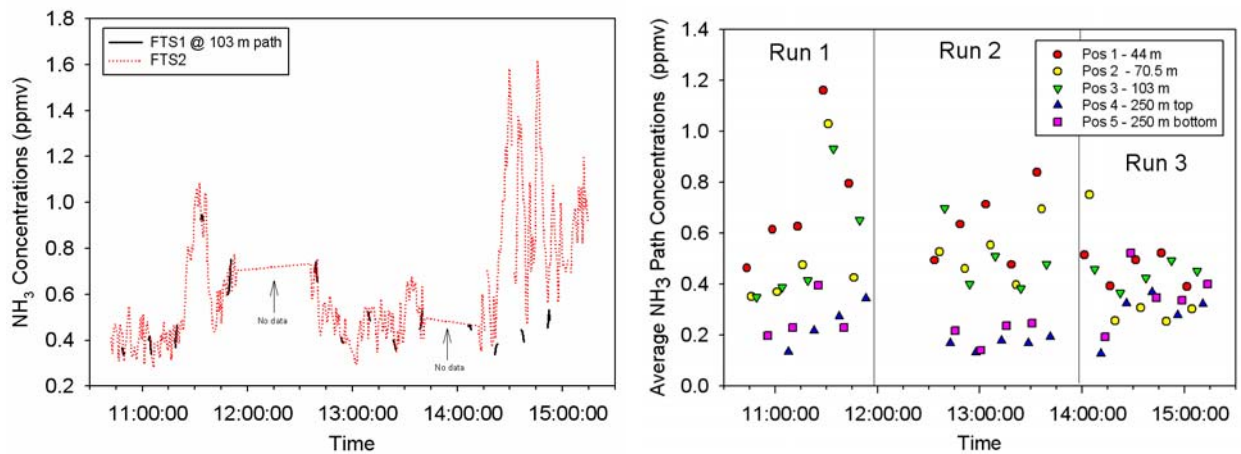

Figure 11 - a) Comparison of scanning (FTS1) and staring (FTS2) FTS data b) open path integrated concentrations for the five different paths (FTS1).

The passive samplers reported concentrations much higher than the FTS systems. Passive sampler data indicates that the largest concentrations are coming from the first set of fans or the ones closest the FTS (Figure 10b). In particular, passive sampler number 1, which was right in front of the first ventilation fan, reported much larger concentrations during the first two sampling periods (Figure 12).

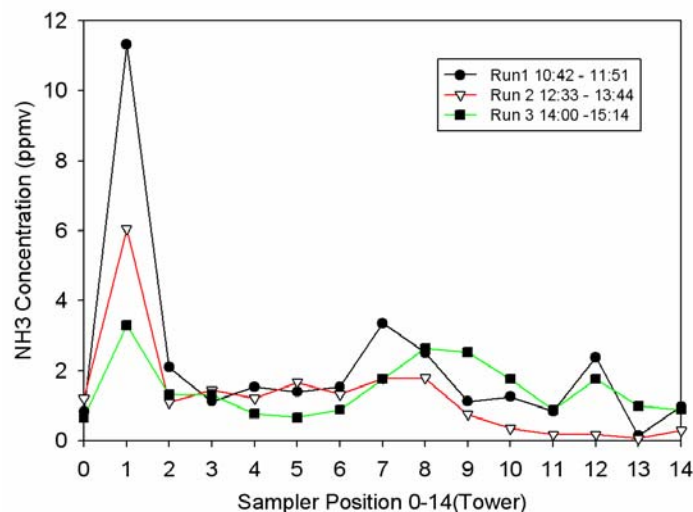

Figure 12 - Time averaged NH₃ concentrations for each passive sampler during three separate hour long runs.

Data collected by the multi-path system along a line at multiple retroreflector distances, can be used to separate the beam path into segments and determine the average ammonia

concentration in each segment. During this experiment, the path was broken into four blocks, each one being separated by a retroreflector. This allowed for the determination of ammonia levels present near the first set of fans (block 1), between the two sets of fans (block 2), near the second set of fans (block 3), and beyond the barns (block 4). These data were compared with the passive sampler results as shown in Figure 13. The concentrations calculated from the spatially separated passive samplers in each block were averaged and compared with the time-averaged concentrations calculated from the scanning FTS for that same block. This was done for each sample period. In other words, a spatial average of time-averaged samples was compared with the total path concentrations averaged over time. The passive samplers and the FTS show the same trends but there is a large difference between concentrations reported using the two methods. On run three though, when winds were low between the barns and most of the ventilation fans were turned off, the concentrations were closer to each other (Figure 13c). This indicates that high winds caused forced diffusion onto the passive samplers.

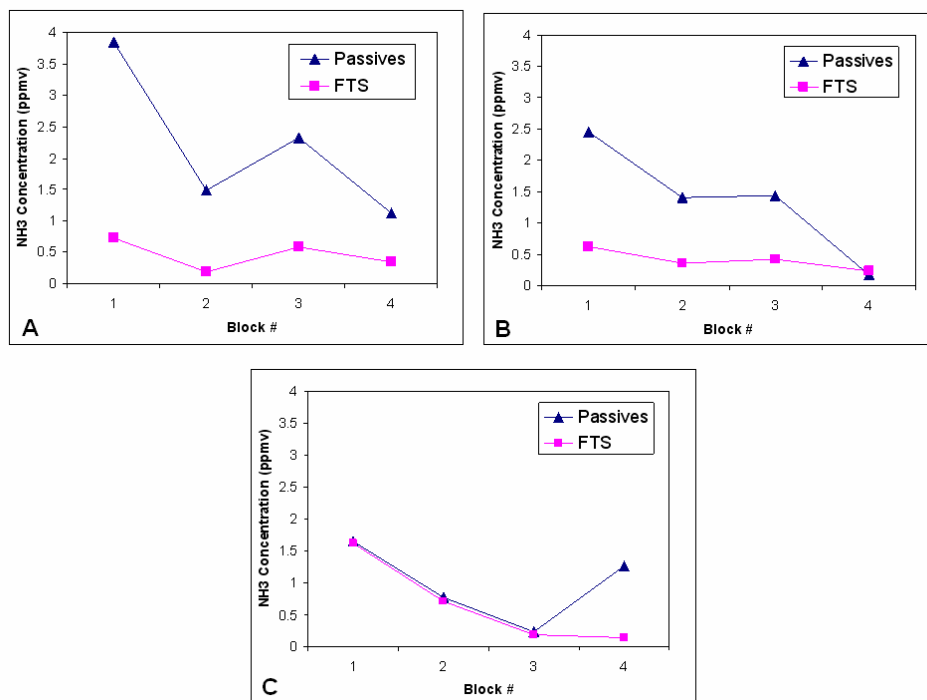

Figure 13 - Comparison of time-averaged FTS and spatially-averaged passive sampler data for each block along the beam path during a) run 1 b) run 2 and c) run 3.

The ammonia concentrations measured during this second experiment at the laying hen facility were much lower than those measured during the first experiment. FTS2, which was staring at the reflector near the end of the barns, shows ammonia concentrations varying from 0.3 to 1.6 ppm (Figure 10) with an average of 0.63 ± 0.27 ppm. This difference between experiments is likely due to the fact that two days prior to the second visit the chickens had been removed from the barn and the barn was in the process of being cleaned out.

Dairy Farm

Another field comparison of the FTS systems and the Ogawa passive ammonia samplers was carried out during October 1-6, 2007 at a large dairy located near Wendell, Idaho. The dairy has a 20-acre wastewater lagoon to store waste collected in the milking parlor and the barns housing the milking cows. The solids in the waste stream are removed upstream of the lagoon

by four adjacent solids-separator basins. The two FTS instruments were set up looking along the east side of the lagoon, the predominantly downwind side, with 10 passive samplers placed at equal intervals along the path. Data were collected in four hour increments. For each run, a new set of passive samplers was deployed along the path. For most of the time at the dairy, the scanning FTS was inoperable due to optics problems. Figure 14 shows the time averaged FTS data for each run compared with the passive sampler data from that run averaged over the whole path.

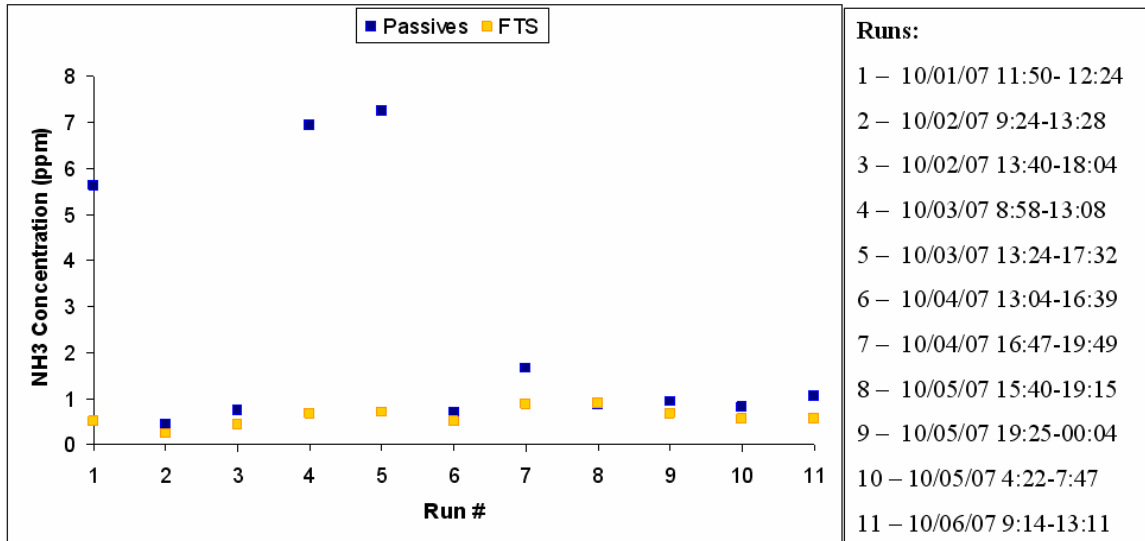

Figure 14 - Comparison between ammonia concentrations as reported by the FTS (average over time for all integrated column data) and passive samplers (spatial average for all time-averaged samples).

During the experiment, it was observed that sometimes much higher concentrations were calculated from the passive samplers. Further investigation into the existing meteorological conditions and operation activities discovered a potential cause for this discrepancy, which may also explain the higher ammonia concentrations calculated from passive samples taken at the laying hen farm near Logan, UT and during the tunnel experiments. During experiments in the tunnel, at the chicken farm, and during runs 1-5 at the dairy, the samplers were deployed without the provided rain covers as the rain covers were considered optional. However, the correlation of higher passive sampler values with increased wind speeds (6-8 m/s) while the covers were off during runs 1, 4, and 5 at the dairy suggests that they should be used at all times. It is hypothesized that at high wind speeds, the diffusive characteristics of the sampler are overcome by the momentum of the molecules, allowing more ammonia to be collected than if the diffusive characteristics held. The caps may provide protection from air motion that could affect the sample characteristics. This hypothesis is supported by two things: (1) this phenomenon was not observed at the low wind speeds measured during runs 2 and 3 with the caps off, and (2) high wind speeds were observed during later runs when rain covers were used, and the calculated ammonia levels agree well with those reported by the FTS (Figure 13). This hypothesis would also explain the higher ammonia concentrations reported by the passive samplers at the laying hen sites and in the tunnel experiments where fans were forcing air past the samplers. If the three data points taken during high wind speeds without the caps in place (1, 4, and 5) are removed, the agreement between the passive samplers and the FTS are closer, with the percent difference averaging 55% and sometimes as low as 0.7% (run 8) as opposed to the 200-1000% differences in previous runs without the covers during high wind events.

Conclusion

In conclusion, well-mixed tunnel studies at short path lengths and using high ammonia concentrations (> 0.5 ppm) were carried out to determine the optimum gain settings for comparison between the two FTS systems. Passive ammonia samplers were also deployed inside the tunnel to provide a comparison with a different measurement technique. The two FTS systems agreed to within 1-20%, depending on gain settings, when the ammonia concentration was above 0.5 ppm. This is the level of the minimum detection limit for these total path length measurement devices at such a short path length. The detection limit of the systems at a 500 m path length was calculated to be ~10 ppb. The concentrations presented by the passive samplers were generally higher than FTS systems.

Two field studies were conducted at a laying hen farm near Logan, UT to test the agreement between the two FTS instruments. During the first test, both systems were mounted on tripods and measuring columns of air perpendicular to exhaust fans from one building. The average ammonia concentrations measured by FTS1, FTS2, and the passive samplers were 3.37, 3.45, and 6.19, respectively. The reported concentrations for the two FTS systems were within 6% of each other. Passive samplers consistently reported higher ammonia concentrations. During the second test, the scanning system was used to look at 5 retroreflectors at different distances and elevations. The non-scanning FTS was focused on one of these retroreflectors and comparisons were made between measurements made on the same retroreflector. Average ammonia levels were 0.5, 0.63, and 1.51 ppm, as reported by FTS1, FTS2, and the passive samplers, respectively. FTS differences were less than 1% and tracked each other well. Passive samplers reported higher concentration levels.

Another comparative test of the FTS and passive sampler systems was conducted at a large dairy in southern Idaho with 11 sample runs. The systems were deployed around a 20-acre dairy wastewater lagoon, with the greatest concentration of passive samplers and the FTS systems set up on the predominantly downwind side. The scanning FTS system was not used due to instrument problems. The stationary FTS recorded averages ranging from 0.23 to 1.7 ppm, while the passive samplers recorded a range of 0.45 to 7.2 ppm. Correlation to deployment techniques (with or without the rain cover) and wind speeds during each sample period revealed that samples collected in high wind speeds (> 6 m/s) and without a cap tended to report much higher ammonia concentrations than the FTS. It is hypothesized that this is due to the momentum of the molecules overcoming the diffusive characteristics assumed when calculating the concentrations, causing more sample to be collected and thus reporting a higher level of ammonia. This hypothesis also explains some of the higher values measured by passive samplers in the tunnel experiments (mixed with fans) and at the chicken farm (in front of exhaust fans). For those days with low wind speeds when the cap was not used and all the days when the covers were used, the average passive sampler concentrations agree relatively well with the average FTS levels (55% average percent difference).

The two FTS systems were found to agree well both in the laboratory and in the field. The scanning FTS system herein described agreed well with the other FTS for the second chicken farm study. Both systems agreed fairly well with the passive ammonia samplers, especially when the passive samplers were deployed with the protective cover. The scanning system may prove to be a very valuable tool in determining ammonia emission characteristics from agricultural facilities due to its ability to measure both spatial and temporal variations in concentration. Future field campaigns are planned to utilize this ability.

References

- Arogo, J., P.W. Westerman, A.J. Heber, W.P. Robarge, and J.J. Classen. 2006. Ammonia emissions from animal feeding operations. In *Animal agriculture and the environment: National Center for Manure and Animal Waste Management white papers*, 41-88. J.M. Rice, D.F. Caldwell, and F.J. Humenik (Ed.). St. Joseph, Michigan: American Society for Agricultural and Biological Engineers.
- Battye, W., V.P. Aneja, P.A. Roelle. 2003. Evaluation and Improvement of Ammonia Emissions Inventories. *Atmospheric Environment*. 37 (2003): 3873–3883.
- Finlayson-Pitts, B.J., and J.N. Pitts, Jr. 2000. Chemistry of the upper and lower atmosphere: Theory, experiments, and application. Academic Press, San Diego, California. 969 p.
- Liang, Y., H. Xin, E.F. Wheeler, R.S. Gates, H. Li, J.S. Zajaczkowski, P.A. Topper, K.D. Casey, B.R. Behrends, D.J. Burnham, and F.J. Zajaczkowski. 2005. Ammonia emissions from U.S. laying hen houses in Iowa and Pennsylvania. *Transactions of the ASAE* 48: 1927-1941.
- Moore, K.D. 2007. Derivation of agricultural gas-phase ammonia emissions and application to the Cache Valley. MS thesis. Logan, Utah: Utah State University, Department of Civil and Environmental Engineering.
- Roadman, M.J., J.R. Scudlarka, J.J. Meisinger, W.J. Ullman. 2003. Validation of Ogawa passive samplers for the determination of gaseous ammonia concentrations in agricultural settings. *Atmospheric Environment*. 37 (2003): 2317–2325.
- Smith, B.C. 1996. *Fourier Transform Infrared Spectroscopy*. New York: CRC Press.
- Shao, L., P. R. Griffiths. 2007. Obtaining Qualitative Information on Trace Species in Continuous Open-Path Fourier Transform Spectroscopic Measurements Using Target Factor Analysis and Related Techniques *Analytical Chemistry*.79: 2118-2124.
- Sharpe, S.W., R.L. Sams, T.J. Johnson, P.M. Chu, G.C. Rhoderick, and F.R. Guenther. 2001. Creation of 0.10 cm⁻¹ Resolution, Quantitative Infrared Spectral Libraries for Gas Samples. *Vibrational Spectroscopy-Based Sensor Systems*. Proc. SPIE 4577.
- U.S. Environmental Protection Agency (EPA). 2004. National Emission Inventory—Ammonia Emissions from Animal Husbandry Operations. EPA 10-26-2005. Washington, D.C.: U.S. Environmental Protection Agency.
- Woodward, M. 2007. Owner/Facility Manager. Personal communication, February 7, 2007.