

DEVELOPMENT OF HONEYWELL'S EARTH REFERENCE ATTITUDE DETERMINATION SYSTEM (ERADS)

Dr. Douglas Pledger
Honeywell Systems and Research Center

James Billing-Ross
Honeywell Satellite Systems Operations

William Saylor
Los Alamos National Laboratory

Abstract

In 1992 Honeywell began development of Earth Reference Attitude Determination System (ERADS), a very small low cost/power/weight attitude reference system designed for small satellite applications. We undertook this development because it appeared to us that small satellites require significantly smaller, lighter, and lower cost attitude reference systems than are currently available. ERADS was conceived as a single, strapdown, three axis sensor that would image the entire Earth's limb in the ultraviolet. The spectral band was selected because it provided feature stability comparable to what is seen in the infrared along with sensor cost and weight characteristic of visible sensors. Although an Earth reference sensor was originally envisioned, it became evident that the ultraviolet was an excellent spectral band to observe stars as well, providing a combined star/sun/Earth sensing capability in a single package. As a result, the current system can provide both three-axis attitude and autonomous navigation data from a single solid-state sensor.

A prototype sensor was fabricated in late 1992. In order to meet the weight and field of view requirements a highly innovative optical and detector assembly was developed. The optical assembly through the CCD has a volume smaller than a coke can and weighs less than a pound. The associated electronics, including an embedded R3000 processor, occupies two 8x10 inch boards. The system was originally designed to provide three axis accuracy of .05°. Subsequent evaluations indicated that a .02° accuracy can be obtained.

In 1993 the optical system has been modified to be more compatible with typical satellite real estate priorities. The field of view has been extended to provide a clear 30° area in the center in addition to the original annular field. These modifications will make it easier to integrate ERADS with satellites and will also improve performance. The resulting sensor package now has a configuration more closely approximated by a tuna can. A processor design incorporating high density interconnect technology is

being developed which will greatly reduce the weight and dimensions. The resulting package should fit within the tuna can envelope.

As the system has evolved, it has become clear that better accuracy can be obtained by relying more heavily on stars for attitude determination, and using the earth limb data primarily for navigation purposes. The combination of earth and star sensing in a single small package should serve to further reduce the burdens of attitude determination for smallsats.

The processor section of ERADS is scheduled for a flight test in 1994. The entire system is under consideration for an experiment on another 1994 flight.

Introduction

The objective of the Earth Reference Attitude Determination System (ERADS) project is to develop a new medium accuracy solid-state attitude determination/navigation system which uses a very wide field of view, ultraviolet CCD camera to sense the stars, sun and earth. (see Fig 1.) ERADS combines a high resolution UV digital camera with a embedded RISC processor with a bus interface architecture to provide the core of an integrated satellite flight management system. In 1992, we developed a first generation system as shown in Figure 2. The system has two components, a remote optical assembly and a electronics slice. This configuration was designed to support the SFMS concept by implementing a high speed SFMS flexprint backplane to interconnect the ERADS core slice with additional payload and spacecraft modules.

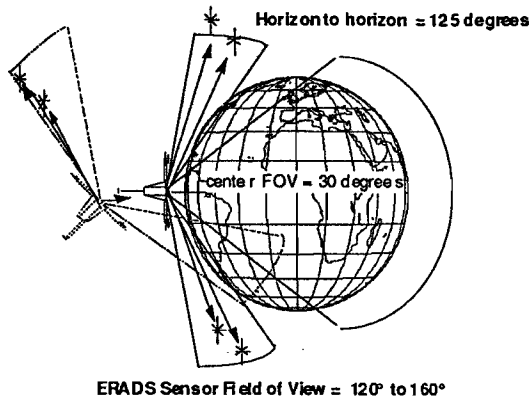

Figure 1. ERADS Combines Star Tracker and Earth Sensor Functions

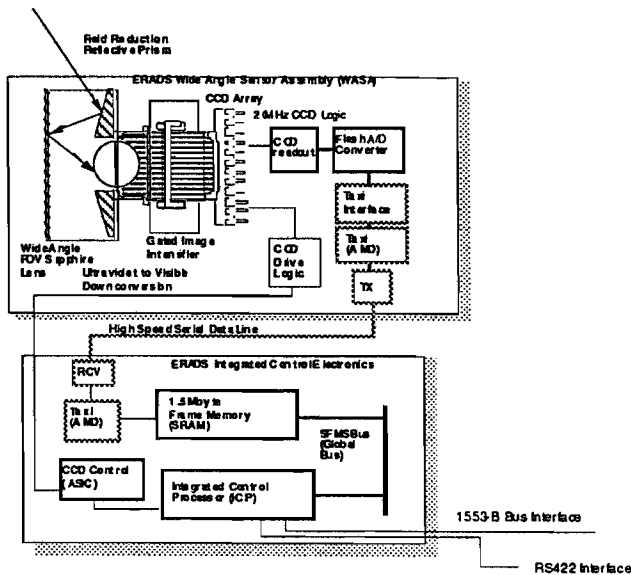

Figure 2. ERADS SFMS "core" system

The ICP module is being developed jointly with Los Alamos National Laboratories (LANL) along with a 24 Mbyte Solid-State Data Recorder as the payload SFMS (p/SFMS) for the Satellite Attack Warning Assessment Flight Experiment (SAWAFE) payload for the Ballistic Missile Defense Organization (BMDO). The ICP and SDDR modules are mounted in a single slice and control 4 experiment modules and a power supply module. The engineering development unit is shown in Figure 3 with the SFMSBus connect visible on the top of the module. In the ERADS system, the ICP and Digital Sensor Electronics(DSE) are single sided cards bonded to the aluminum thermal substrate to form a single module. The SFMSBus connection between the two cards is

made through the bus connector. In the SAWAFE unit, the ICP and SDDR share the same slice.

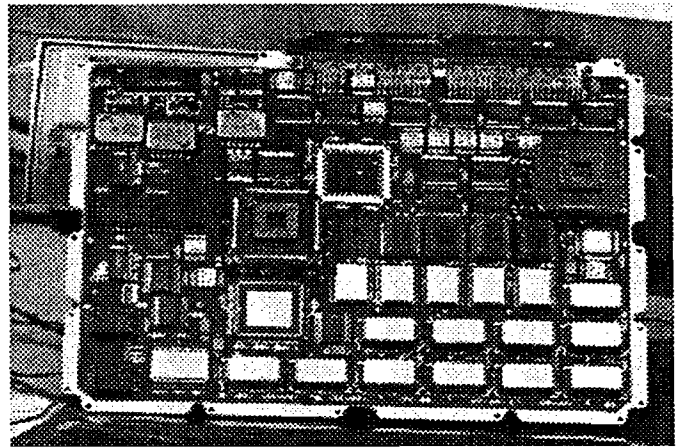

Figure 3. Engineering Model of ICP module

The first generation Wide Angle Sensor Assembly is shown in Figure 4. with actual optics and mockup electronics. The brassboard electronics currently fits on a 5 inch ,double sided, surface mount printed circuit board.

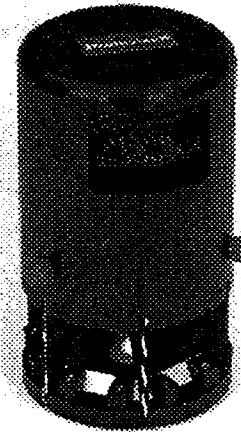

Figure 4. Wide Angle Optics (1st generation design)

The first generation brassboard is currently undergoing integration and test, using an IDT RS785 development board in place of the actual ICP module. This system configuration will be used for software development and checkout of the realtime operating system, focal plane processing and attitude determination and navigation modules.

Software Development For The ERADS SFMS

One advantage of using a 32-bit processor is the both the availability of commercial software development

tools and the increased flexibility available to the applications software developer. Many of the development risks associated with programming older 8 and 16 bit DoD processors such as the 1750 are significantly reduced by using a processor architecture with a large address space as well as sufficient throughput margin. A major myth of the traditional space industry is that more MIPS cost equivalently more dollars and so great lengths are taken to size the processor to the application. Unfortunately, if the code estimates are low (and they usually are) or new features are desired, complex and costly changes are required to the hardware. In addition, current generation CPUs such as the R3000 are usually cheaper than their older cousins due to the high commercial production runs. The ERADS SFMS is based on a radiation enhanced military version of IDT's R3081 CPU and provides an address range of 4 GBytes as well as 20 MIPS. This physical address space is addressable from virtual memory via the R3000 memory manager unit (MMU) which allows the applications developer to select cached or direct memory access as well as the ability to map virtual addresses to physical addresses under software control.

The basic memory mapping available for the IDT R3081 CPU is shown in Figure 5.

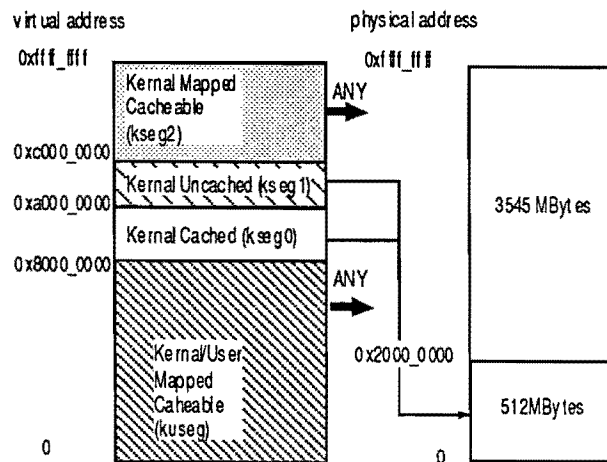

Figure 5. Virtual to Physical Memory Mapping for R3081

The SFMS architecture takes advantage of this capability for memory mapping and provides a high speed local bus (SFMSBus) via a backplane connection to connect other payload or spacecraft modules to the SFMS Integrated Control Processor. This allows the modules to be memory mapped making access and control of the modules straightforward.

The advantage of this architecture is that the hardware is very generic with most of the application specific functions being handled in software. An example of this system flexibility is the ability of the systems developer to directly access and process the sensor pixel data rather than just receiving processed data. While ERADS ADNS modules will provide attitude data much the same as a tradition star tracker, the developer can do additional processing for other applications or replace the supplied algorithms with ones better suited to the specific mission application. This allows both use of the sensor data for other functions (payload sensing, etc) as well as allowing reprogramming of the sensor on the fly. In fact, the camera A/D offsets and gains can also be programmed by the ICP, allowing recalibration of the CCD over the life of the system. This contrasts from tradition approaches where the star tracker is application specific and treated as a black box. The frame store for the ERADS camera is accessed from the ICP over the high speed SFMS backplane and appears as a region of memory which is nominally mapped into an array of 8bit integers. The SFMS software supplied with the system contains modules which process this data to extract objects of interest for the attitude determination and navigation problems such as stars, the sun, and the Earth, which is fed into the attitude determination /navigation modules along with data from the on-board ephemeris and star-identification modules.

SFMS Physical Memory Map		512 MBytes
Payload Address Space		480 Mbytes available for memory mapping payload modules, TLM/CMD modules etc
UV Sensor Image Frame Data		32 Mbytes
Program Memory (EEPROM)		lower 32Mbytes reserved for SFMS
CPU status,DMA,EDAC		
1553 control/memory		
DUART control		16 MBytes
payload module discretes		
reserved for memory expansion		4 MBytes
ICP Memory (SRAM)		

Figure 6. Memory Map for SFMS System

Another feature of the SFMS architecture is that IDT's RS785 development board can be used to simulate the ICP. The 785 has the R3081 with 1 Mbyte of DRAM and RS422 interfaces and sells for under \$1000. The addition of an adapter module with a SFMSBus connector provides a very low cost development unit which can be used for software development and application module checkout. This allows each engineer to develop and checkout hardware using a dedicated PC or workstation and development board without having to worry about scheduling a scarce development unit. This approach has been used on the SAWAFE program and has allowed parallel checkout of the different modules as well as checkout out of the ICP module itself. Figure 7. shows the SAWAFE SSSR card connected to a modified 785 development card via the SFMSBus flexprint backplane.

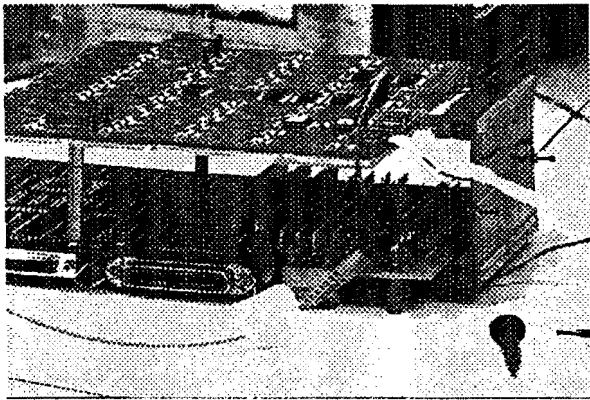

Second Generation Design Optics Design

The second generation ERADS sensor is currently being fabricated. Although the basic design is unchanged, several modifications have been incorporated which significantly improve performance. The first of these relates to the viewing geometry. In the original configuration, shown in Figs 8 and 9, the scene was reflected from a set of six mirrors into a spherical lens. In order to implement this, it was necessary to place the lens and the detector outside of the satellite skin. This required that high voltage and data lines be fed through the fin structure, which proved to be somewhat undesirable. It was also found that integration with the satellite would be difficult for some applications. Consequently, a second mirror surface was included, which "bounced" the image back toward the satellite part of the sensor. This modification allows the detector along with all power and data lines to be located inside the skin. The new configuration is shown in figure. 10

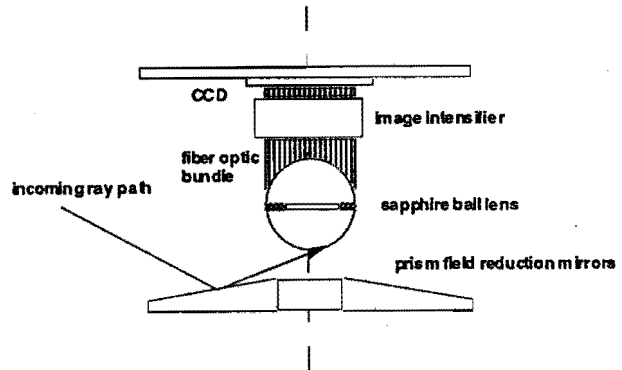

Figure 8. 1st Generation Optical Design

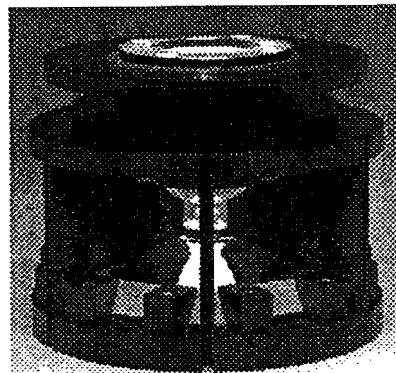

Figure 9. Prototype Optical Assembly (1st gen.)

The second generation design also permits an expansion of the sensor field of view. The original sensor viewed an annular region of space, typically from 65 to 75 degrees from nadir. This provides a capability to view additional terrestrial objects, or to move the detector axis off nadir for different observational geometries. It is also possible to use different color bands for the center and annular parts of the field.

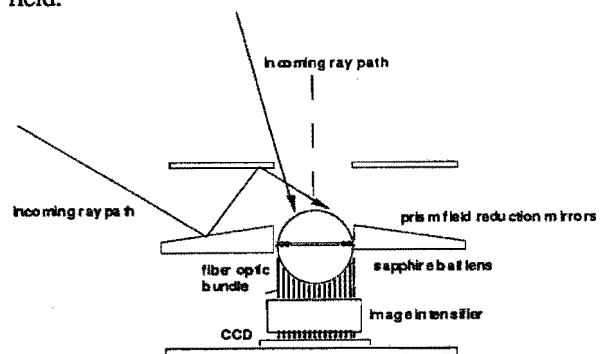

Figure 10. Second Generation Optical Design

The error analysis conducted for the first generation sensor indicated that the largest contribution came from the photon counting statistics for stars. It was found that if the

sensitivity of the sensor could be increased by a factor of two or so, accuracies significantly better than our original objective could be obtained. The two factors limiting the sensitivity of the ERADS sensor were its small (one square centimeter) aperture and the narrow (200 Angstroms) waveband. The former resulted from the basic characteristics of the spherical lens, and the requirement for resolution on the focal plane. The latter derived from a minimization of the dynamic range between day earth limb and stars. Reconsideration of this issued showed that it would not be possible to extend the waveband toward the visible, but that including a larger region on the short side would not impact dynamic range enough to cause problems, and would have some beneficial effects. In particular, the ratio of average stellar intensity to day limb would actually increase slightly, while the relative intensity of the night limb would be somewhat reduced. More significantly, the solar intensity with respect to all of these objects decreases somewhat. This is important for ERADS, since the sensor is designed to operate with the sun in the field of view, eliminating the cost and weight associated with sun shields.

These effects occur because of the source of the day limb illumination, and the temperature of the sun relative to the "average" star. The day limb is defined by Rayleigh scattering from atmospheric gases. This scattering increases as the inverse fourth power of wavelength and, consequently, a higher percentage of incident solar energy is scattered for wavelength below 2800 A then for those above. As a result, expansion of the ERADS waveband on the short side increases the limb/sun intensity ratio.

The sun is a relatively cool star, and has its spectral peak in the visible. The majority of brighter stars are hotter, and have their peaks in the ultraviolet. Statistically, the average star is brighter below 2800 A than is the sun, and expansion of the ERADS band will enhance the brightness ratio of the average star with respect to the sun. The night limb shows most of its intensity below 3000 A between 2800 A and 3000 A (which is one reason why this band was originally selected.) Consequently, the intensity added by broadening the band will be somewhat less than for the day limb. As the resulting ratio is still within the dynamic range of the sensor, we do not see this as an issue.

The problem which we faced at this point was how to increase the spectral bandwidth and the

aperture while maintaining the required spatial resolution. This was limited in the original design by spherical and longitudinal chromatic aberrations. The "classical" approach to this problem, which has been taken by others developing similar sensors, is to incorporate concentric elements of different refractive index to compensate for these effects. Such a design ran counter to the ERADS objectives, however, in that inclusion of such elements greatly increases the cost, complexity, and alignment problems associated with the sensor. In addition, analysis showed that the improvements which could be realized were not as large as required. Consequently, another approach was sought.

The design which ultimately emerged consists of a diffractive pattern applied to one half of the spherical lens, which is now fabricated in two sections and optically rejoined after application of the pattern. It was found that this approach results in a significant reduction on both of the principal aberrations, allowing an increase in waveband from 200 to 400 Angstroms and an increase in aperture by a factor of three in sensitivity is achieved.

Sensor Processing

The ERADS system provides essentially a programmable digital camera to the system developer. The software drivers provided allow control of both exposure time and frame rate as well as providing the capability to adjust the digitization. The camera provides an interrupt to the processor everytime a image frame is dumped into memory. An interrupt handler then acknowledges the interrupt and schedules the focal plane processing routine. The basic processing flow is shown in Figure 11. In the acquisition mode, the initial processing scans the focal plane to determine the available objects, group the pixels and classify the objects according to whether it is the Earth, the Sun, stars or others. Each track object identified is then centroided and sorted according to accuracy. The top five vectors are then correlated with their associated reference vectors which are derived either from ephemeris data or from the star identification module. Currently a QUEST quaternion estimation algorithm is used to derive the attitude quaternion from the available track vectors. A Kalman filter is also being developed which will be driven by gyro data from Honeywell GG1320 or GG1308 RLG based IMUs with attitude updates from the ERADS sensor. Example timing for the gyroless system application is shown in Figure 12 with the gray areas showing processing resources available for other mission specific applications.

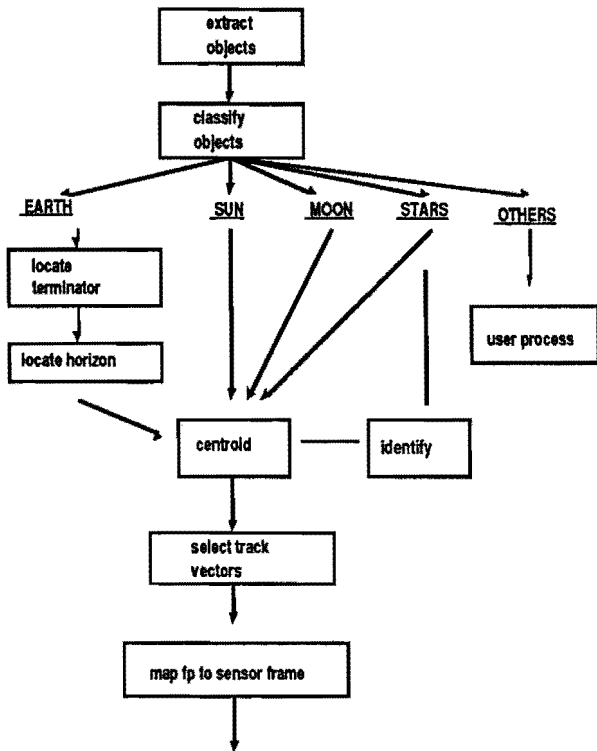
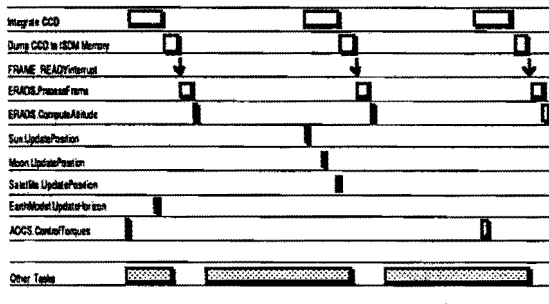
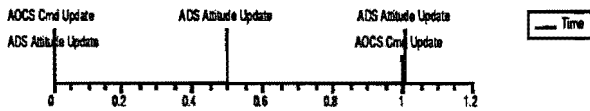

Figure 11. Focal Plane Processing Flow



Navigation data is obtained from a simple celestial fix from Earth size and location and star location data. Because all of the measurements are simultaneous, the need for filtering is minimized.

Sensor Parameters

The following characteristics of the ERADS system can be summarized for the planned flight experiment as follows:

Sensor Characteristics

Field of view	133-143 degrees 30deg. boresight
Collecting aperture	1 square centimeters
IFOV	0.04 degrees
Spectral band	<3000A
Lens material	sapphire
Optical efficiency	.5
Detector	ITT Intensifier tube Kodak KAF1300 CCD

System Characteristics

Weight	2.0 Kg
Power consumption	23 watts for system sensor/processor core
Output (2Hz)	3 axis attitude derived rate
(0.1Hz)	3D position
Pitch uncertainty	<.02 degree
Roll uncertainty	<.02 degree
Yaw uncertainty	<.02 degree
Navigation uncertainty	TBD
Volume	3000 cubic centimeters
Throughput	20 MIPS, 7.4 MFLOPS @ 25 Mhz
Memory	4 Mbytes SRAM(EDAC) 128Kx32 EEPROM
Processor	IDT R3081RE
Interface	Mil-Std1553B dual RS422

Development Status

The technology development plan for ERADS is shown in Figure 13. The SAWAFE ICP and SDR are scheduled to fly on STEP 3 in 1994. Honeywell's internal development program is focused on developing the flight prototype and obtaining a launch for a flight test in late 1994. LANL and Honeywell are working on upgrading the ICP with custom rad-hard ASICs to replace the FPGAs currently in use. This would provide additional capability such as memory scrubbing and fully redundant 1553 channels as well as reducing part count and increasing speed. In addition, a pilot program is being designed to shrink the whole ICP processor into a small MCM approximately 2 sq. inches using High Density Interconnect technology. This would further reduce power and weight and allow the entire subsystem to be packaged in a 3" wide by 5" long cylinder.

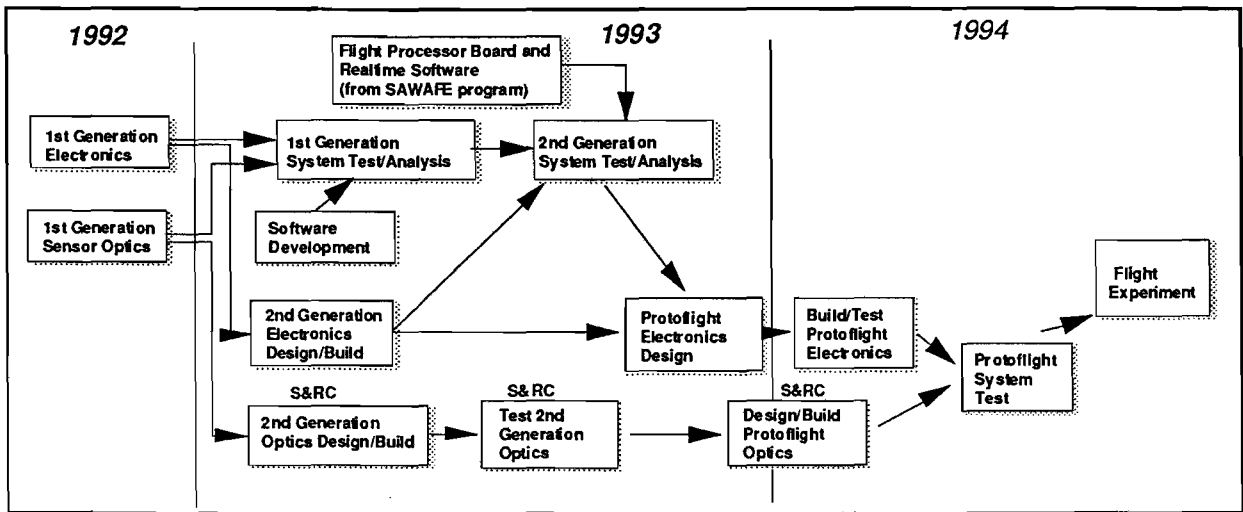

Figure 13. ERADS Development Plan