

**LOW COST ATTITUDE SENSORS
FOR SPACECRAFT***

**S. Auer and F. O. von Bun
Applied Research Corporation
8201 Corporate Drive, Suite 920
Landover, MD 20785**

**Presented at the AIAA/Utah State University Conference on Small Satellites
August 28-31, 1990*

ABSTRACT

A short overview is presented on low cost attitude sensors developed by Applied Research Corporation. More or less existing technology has been used, but major emphasis was directed to considerably reduce the cost of these units without compromising their quality and reliability.

Horizon and sun aspect sensors have been developed and manufactured. They were successfully flown on the space shuttle Atlantis (STS 34, October 18, 1989). We have further manufactured 10 horizon sensors and 15 sun aspect sensors and delivered them to Goddard (Wallops) Space Flight Center for future use on sounding rockets.

The angular errors are about $\pm 0.1^\circ$ to 0.2° for the horizon and sun aspect sensors. Their mass is about 0.3 to 0.8 kg and their power requirement about 0.1 to 1.5 W.

We have recently won a contract with Goddard to develop a low cost star tracker with an angular error of about ± 5 sec of arc. Our plan is to produce a protoflight unit of such a sensor in about 24 months.

Some details of the results obtained from the shuttle flight and some system details will be presented.

SOLAR ASPECT SENSOR (SAS)

Design

The Solar Aspect Sensor (U.S. Patent No. 4,794,245) is shown in Figure 1 and was developed to determine the sun's angle with respect to the optical axis of the Shuttle Solar Backscatter Ultraviolet (SSBUV) experiment package. This angle is determined with an accuracy of $\pm 0.1^\circ$. The sensor is mounted on the SSBUV front panel, with its viewing axis aligned with the axis of the SSBUV. The SAS is used when the SSBUV is in the sun-viewing mode.

The SAS has a field of view of 32° square (normal mode), and responds to solar radiation in the blue-green portion of the spectrum. It contains two channels for measuring orthogonal components, α and β , of the sun's angle (see Figure 2). In each channel, sunlight passes through a narrow slit and strikes a linear array of light sensors (see Figure 3).

Signal processing electronics determine the location of the center of the sun's image on the array, using sensor readings which are updated every 5 milliseconds. The sensor output consists of 16 serial bits at 8,320 bps and is synchronized to the SSBUV data format. The sun's angle α , in the x-channel, is determined from the first 8 bits of the output reading (X_c), using the formula:

$$\alpha = \text{arc tan } [2.54 \times 10^{-3} (X_c - 127)].$$

The angle β , in the y-channel, is determined from the last 8 bits of the output reading (Y_c), using the formula:

$$\beta = \text{arc tan } [2.54 \times 10^{-3} (Y_c - 127)].$$

The total angle γ , between the sensor's axis and the center of the sun, is

$$\gamma = \arctan (\tan^2\alpha + \tan^2\beta)^{1/2}$$

The required measurement accuracy is $\pm 0.1^\circ$. The sensor can be commanded in a wide-angle/high-resolution mode. In this mode, the field of view is increased to 64° square. The sensor output consists of 24 serial bits, and the measurement accuracy is $\pm 0.04^\circ$. The sensor performance and essential parameters are given in Table 1.

Sensor Operation

Both x and y optical channels consist basically of an entrance slit and a linear Charge-Coupled Device (CCD) array (see Figure 3). The CCD array consists of a string of 2,048 light-sensitive silicon elements. The CCD array, slit, and sensor axis are mutually orthogonal.

Radiation from the sun imaged by the slit on the array produces electron-hole pairs in the array elements. The electrons are collected in these elements and this quantity of charge is proportional to the incident flux and exposure time.

After an exposure of 5 milliseconds, the charge packets of all elements are simultaneously transferred to a parallel array of temporary analog storage registers. From there, they are serially shifted to a charge sensitive output amplifier. Finally they are fed into a voltage comparator which identifies those elements which have received at least 50 percent of the light at the center of the sun's image. The address of the first sun-illuminated element, X_L , and the total number of sun-illuminated elements, X_w , are combined to produce the address, X_c ,

$$X_c = X_L + 1/2 X_w,$$

denoting the serial number of the element where the center of the sun's image fell, with one-half count accuracy. Similar operations are used in the y-channel, leading to the address, Y_c ,

$$Y_c = Y_L + 1/2 Y_w.$$

A functional block diagram of the ARC SAS is shown in Figure 4.

EARTH HORIZON SENSOR (EHS)

Design

This sensor is shown in Figure 5, and was designed and developed to measure the nadir angle with respect to the optical axis of the SSBUV experiment package, to an accuracy of $\pm 0.5^\circ$. Four identical Earth Horizon Sensors are mounted on the SSBUV front panel. They view 75° from the SSBUV axis to intercept the Earth's horizon at 90° intervals, as shown in Figure 6.

Each sensor is sensitive to infrared radiation between 14 and 16 microns which is emitted by the CO_2 layer above the Earth's atmosphere. Its instantaneous field of view is 2° (vertical) by 5° (horizontal). A rocking mirror inside the sensor scans the field of view (10° , containing the horizon and parts of the sky and the Earth), across the detector.

The signal processing electronics determine the fraction of each scan period during which the field of view dwells inside the atmosphere boundaries. The sensor readings are updated every second and its output consists of 8 serial bits at 8,320 bps and is synchronized to the SSBUV data format. The angle between the sensor's axis and the horizon (α) is determined from the output reading (X) using the formula:

$$\alpha = A_0 + A_1X + A_2X^2 + A_3X^3 + A_4X^4 + A_5X^5$$

where A_0 A_5 are constants.

The noise-equivalent angle is less than 0.1° . The sensor performance and general characteristics are given in Table 2.

Sensor Operation

A schematic of the sensor is shown in Figure 7. Infrared radiation (14-16 microns) from the atmosphere is reflected by a rocking mirror onto the detector. The mirror is scanned backwards and forwards by a stepping motor such that the scan path crosses approximately 5° above and below the horizon. Each scan takes less than 1 second. The reflected radiation is collected by an $f/1$ germanium lens, passes through an interference filter (14-16 micron), and is focussed onto a miniature (2 mm x 0.6 mm) multijunction bismuth/tin thermopile. The detector is hermetically sealed in a purged atmosphere of xenon and heat treated to ensure long-term stability. As radiation is absorbed, the thermopile heats up and generates a voltage which is proportional to its temperature.

After a change in radiation is received, thermal equilibrium is reached within typically 100 milliseconds. The amplitude of the thermopile output in response to the horizon transition is typically 14 microvolts.

An ultra-low noise preamplifier amplifies the thermopile output by a factor of 4,000. After the dc-bias has been removed, the signal is passed through a 1kHz 4-pole Butterworth low pass filter which eliminates the high frequency noise component and amplifies the signal by another factor of 10. In a separate circuit, the time

differential of the signal is derived and added to the original signal. The sum of the two signals closely represents the amplitude and duration of the radiation input into the thermopile, provided the time constant of the differentiation circuitry is carefully matched to that of the thermopile.

Minimum and maximum hold circuits sample the signal voltages which correspond to the radiation from the sky (minimum) and from the Earth's atmosphere (maximum). The arithmetic mean of the sampled voltages represents the definition of "horizon" and is used as a threshold.

The fraction of each scan period during which the signal voltage is above the threshold is measured with an accuracy of 8 bits and is provided as the data output to the SSBUV data storage system.

Star Tracker Development

We have recently won a contract with the Goddard Space Flight Center to develop a low cost solid state (CCD) star tracker. This tracker shall replace the present NASA Standard Star Tracker. The objective of our effort is to deliver, by the end of 1992, a proto-flight model having the following features:

- Accuracy 10 arc seconds
- Update period 1 second (nominal)
- Tracking capacity 1 to 5 stars
- Output data coordinates and magnitude of each star
- Field of view 8° x 8°
- Limiting star magnitude 4 (no cooling)
7 (with cooling)
- Power consumption 5 Watt (no cooling)
8 Watt (with cooling)
- Mass 5 kg (with cooling)
4 kg (no cooling)
- Dimensions 10 cm (diameter) x 20 cm (length)

FLIGHT RESULTS

One Solar Aspect Sensor (Figure 1) and four Earth Horizon Sensors (Figure 5) were flown on the space shuttle Atlantis (STS 34, October 18, 1989) as part of the SSBUV experiment package. Figure 8 is a photograph of the shuttle bay area taken by an astronaut during the flight, with the SSBUV canister attached to the side wall of the bay and the lid open. Two of the four Earth Horizon Sensors are visible inside the opening. Figure 9 is a close-up view of the front deck of the SSBUV.

The sensor data were recorded on magnetic tape during the flight and played back and processed after the flight. Figure 10 is a plot of the sun angle versus time during one of the sun-viewing phases. Note the typical period (~5-10 minutes) and amplitude (~2 degrees) of attitude corrections performed by the shuttle is clearly visible. Figure 11 is a plot of the x versus y output covering the same period as in Figure 10. It can be seen that a quantization step (either axis) is approximately 0.15 degree (quantization error ± 0.075 degree) as expected.

Similarly for one of the four Earth Horizon Sensors, Figure 12 shows a plot of the horizon angle versus time during one of the earth-viewing phases. Again the typical period (~5-10 minutes) and amplitude (~2 degrees) of attitude corrections by the shuttle. Also, the noise-equivalent angle was found to be less than 0.1 degree (rms), as expected from ground testing.

CONCLUSION

We have demonstrated that low cost Solar Aspect Sensors and Earth Horizon Sensors can indeed be manufactured.

The tests performed on the shuttle Atlantis flight during October 1989 demonstrated that their specifications can be met.

We are quite confident that we can also design and manufacture a low cost Star Tracker for NASA-Goddard.

ACKNOWLEDGEMENTS

The development of the Solar Aspect Sensor and the Earth Horizon Sensor was supported by the SSBUV project (E. Hilsenrath, Principal Investigator; D. Williams, Experiment Manager), while the development of the Star Tracker is being supported (contract No. NAS5-31169) by the Special Payloads Division (T.J. Budney), both of the Goddard Space Flight Center.

TABLE 1

SOLAR ASPECT SENSOR (SAS) -- TYPICAL SPECIFICATIONS

• Accuracy	< $\pm 0.04^\circ$ (12-bit mode) < $\pm 0.1^\circ$ (8-bit mode)		
• Field of View	32° x 32° (8-bit mode) 64° x 64° (12-bit mode)		
• Power Interface			
Voltage	+ 28V Continuous		
Current	58 mA (1.6 Watt)		
• Physical Interface			
Size	53 x 104 x 109 mm		
Mass	750g		
Thermal	-20 C to +60° C		
• Data Interface			
Clock	8,320 Hz		
Enable	16 Clock periods (8-bit mode)		
• Vibration and Acceleration			
<u>Frequency (Hz)</u>	<u>g/Hz</u>	<u>SLOPE</u>	<u>g(rms)</u>
20	0.025	--	
20-50	--	+6 dB/octave	
50-600	0.150	--	12.9
600-2,000	--	-4.5 dB/octave	
2,000	0.025	--	

TABLE 2

EARTH HORIZON SENSOR (EHS) -- TYPICAL SPECIFICATIONS

- Accuracy < $\pm 0.5^\circ$
 noise-equivalent angle < 0.1° (rms)
- Scan Angle - 5° to + 5°
- Instantaneous
 Field of View 5° (horizontal) x 2° (vertical)
- Power Interface
 - Voltage + 28V \pm 4 V Continuous (Normal Operation)
 \pm 150V Continuous (Survive)
 - Current 62 mA for 0.935 sec each sec
 180 mA for 0.065 sec each sec
 70 mA Average (2 Watt)
- Physical Interface
 - Size 49 x 102 x 102 mm (Housing)
 - Mass 720g
 - Thermal -20°C to +60°C
- Data Interface
 - Clock 8,320 Hz
 - Enable 8 Clock periods
- Vibration and Acceleration

<u>Frequency (Hz)</u>	<u>g/Hz</u>	<u>SLOPE</u>	<u>g(rms)</u>
20	0.025	--	
20-50	--	+6 dB/octave	
50-600	0.150	--	12.9
600-2,000	--	-4.5 dB/octave	
2,000	0.025	--	

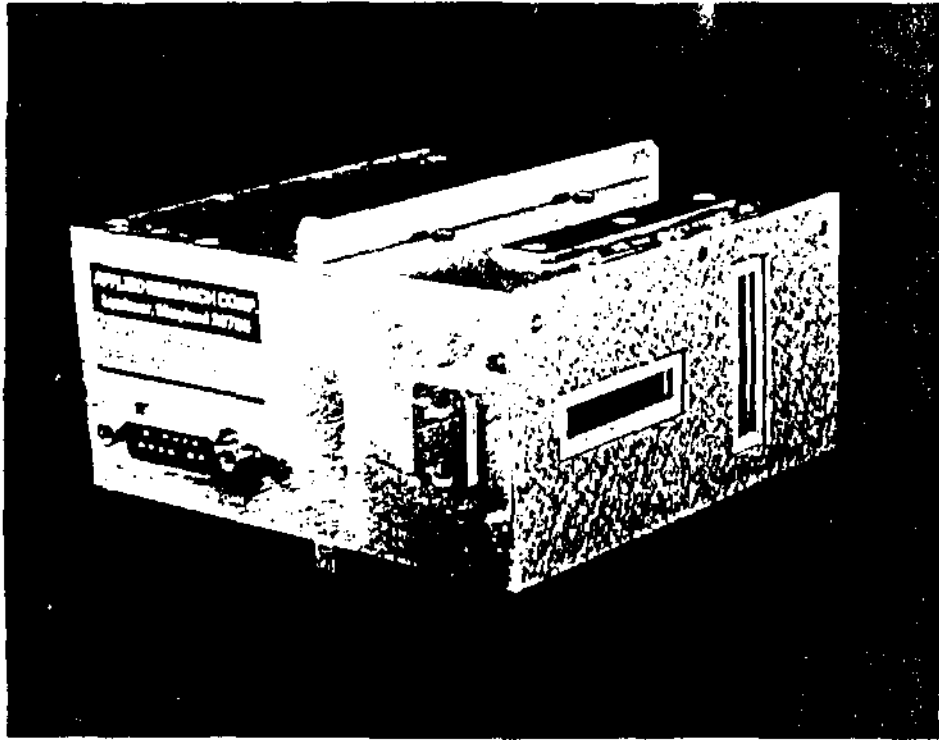

Solar Aspect Sensor (SAS)

Fig. 1

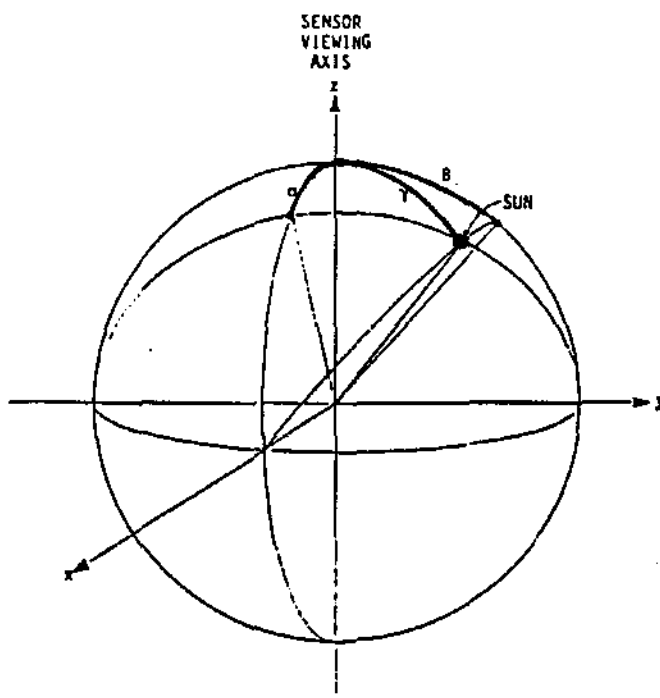

Figure 2. Sun's spherical coordinates in sensor's coordinate system

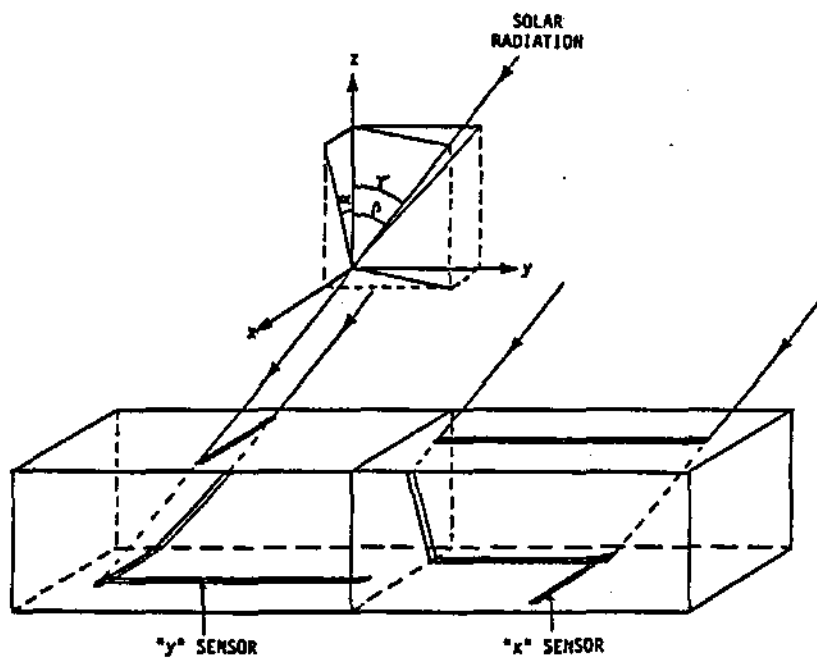

Figure 3. Schematic showing separation of sun's rays into x and y components

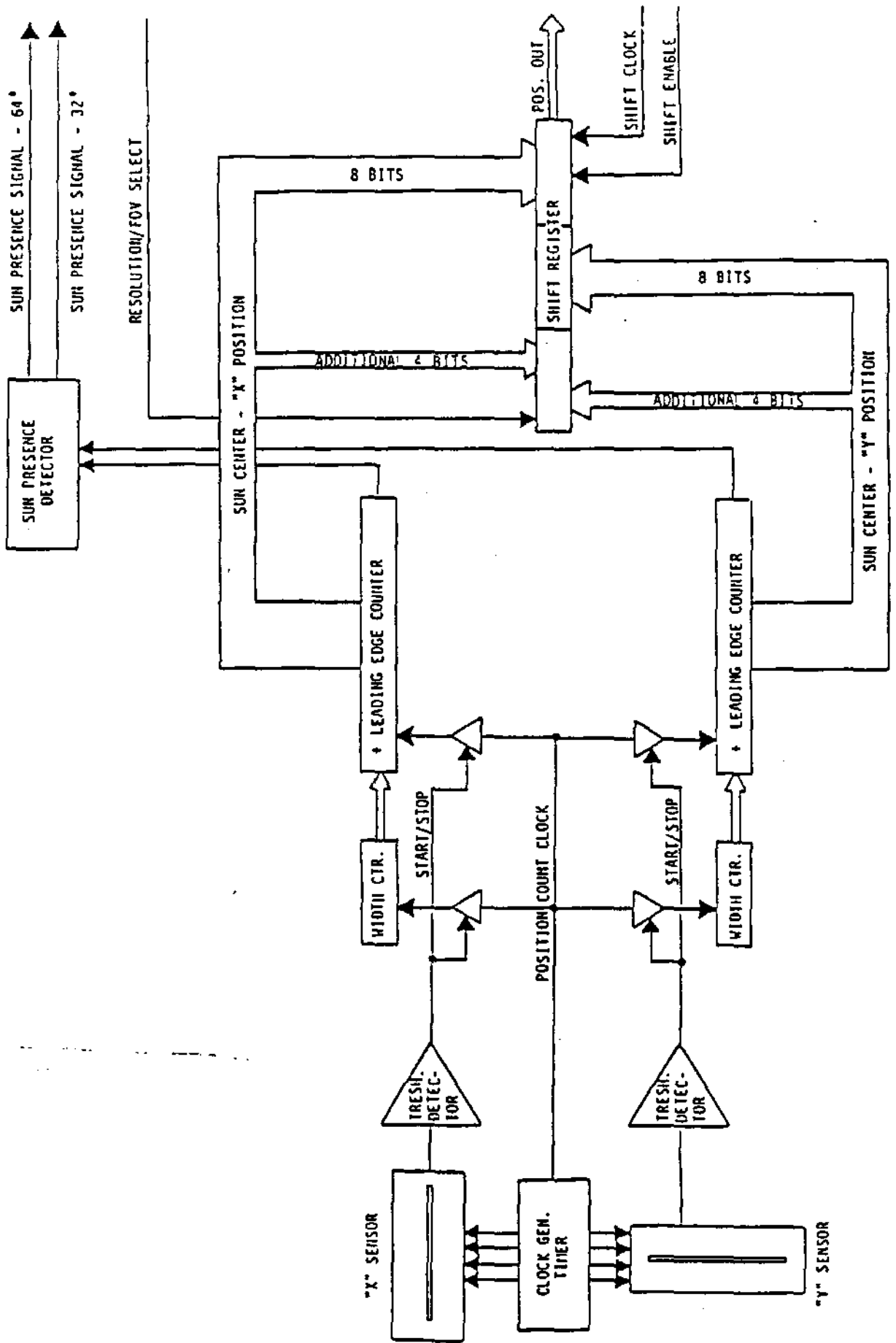
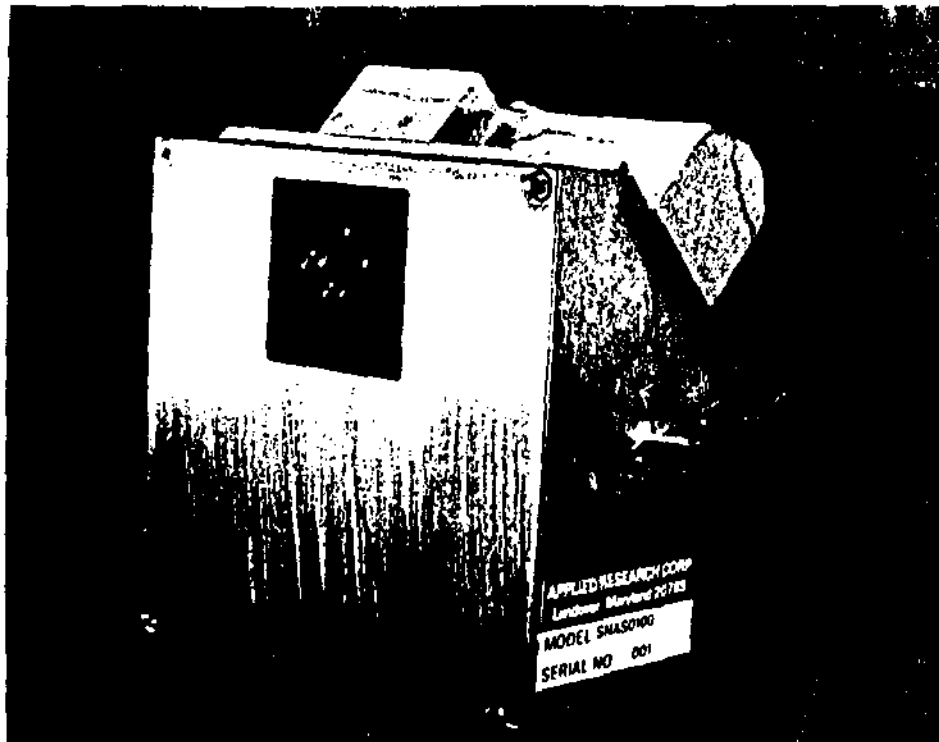

Figure 4. ARC Solar Aspect Sensor Functional Block Diagram



Solar Horizon Sensor (EHS)

Fig. 5

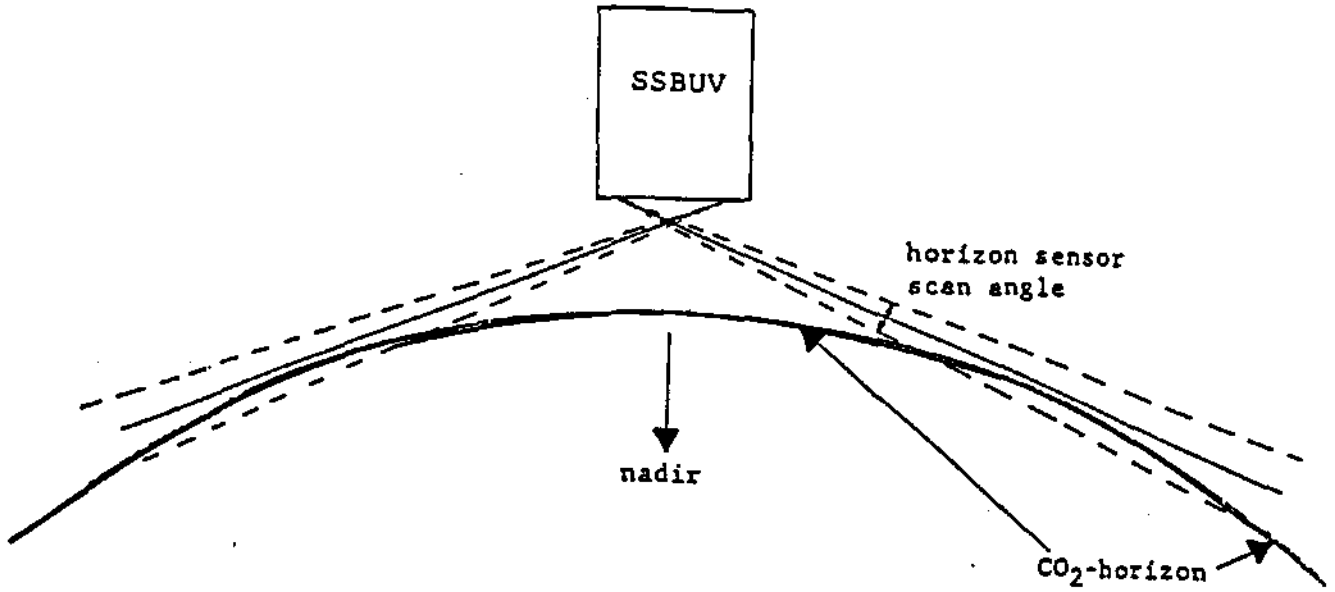

Figure 6. Aspect determination by a horizon sensor using a scanning mirror

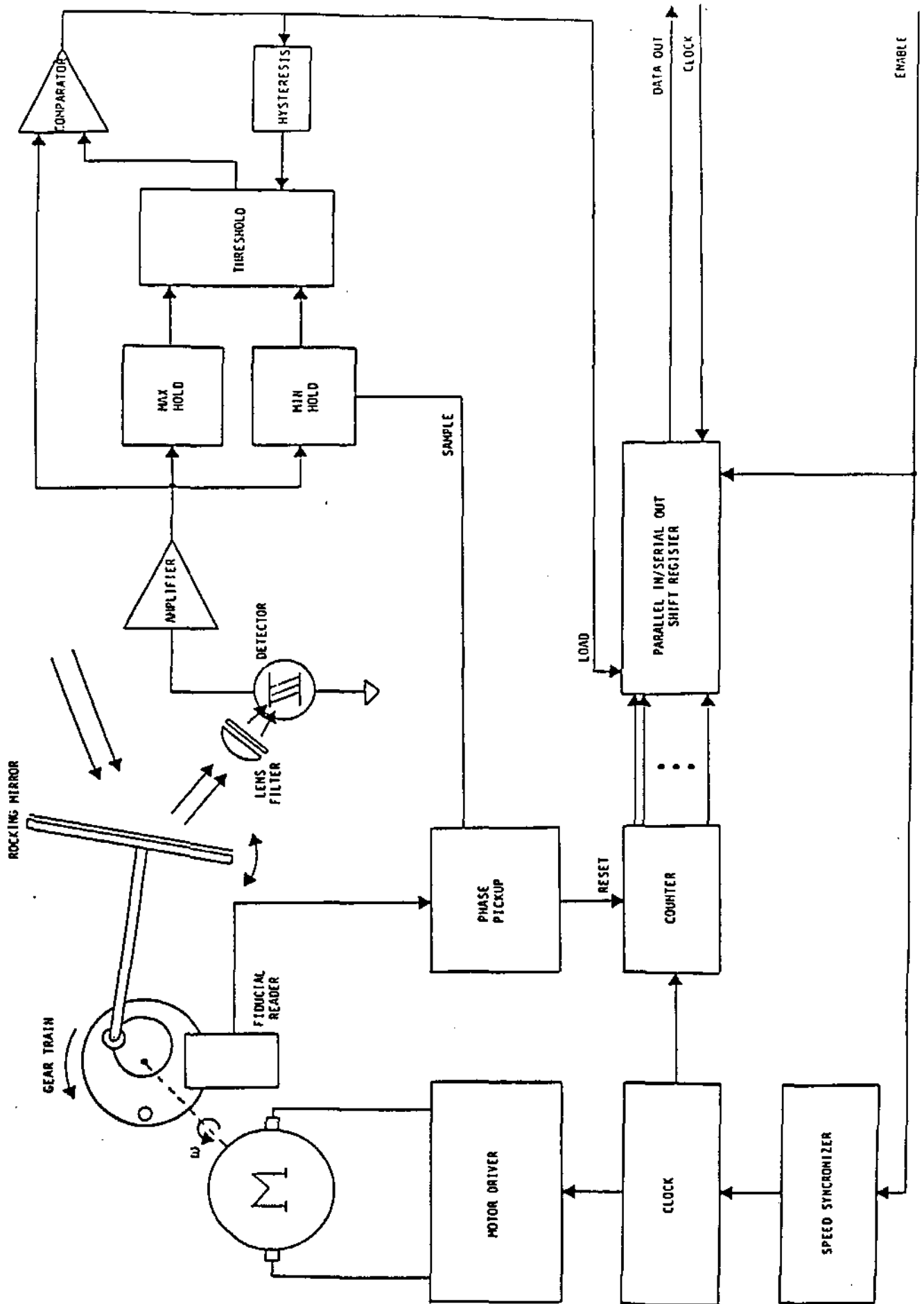

Figure 7. SSBV NADIR SENSOR

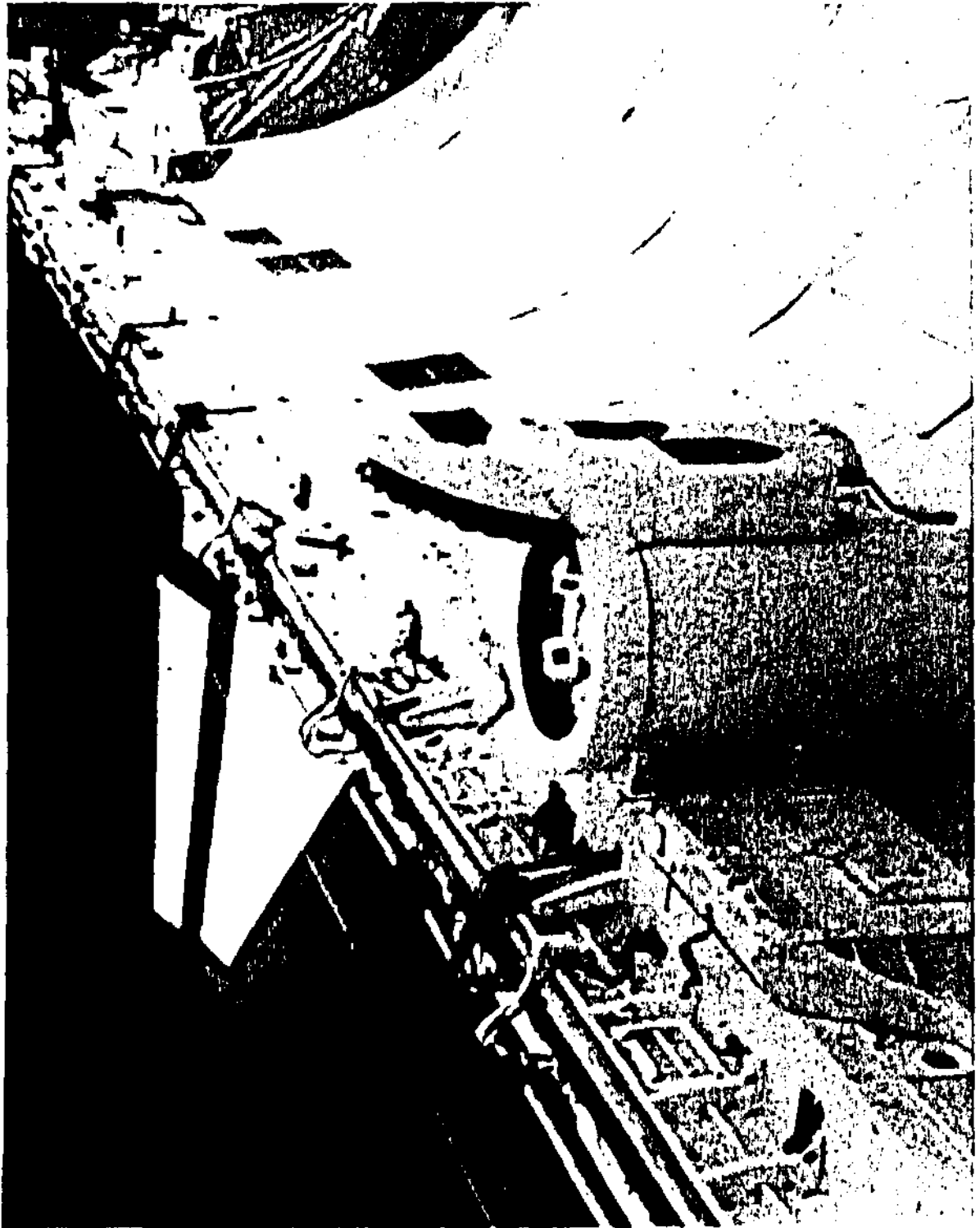

Figure 8: SSBUV canister attached to shuttle.

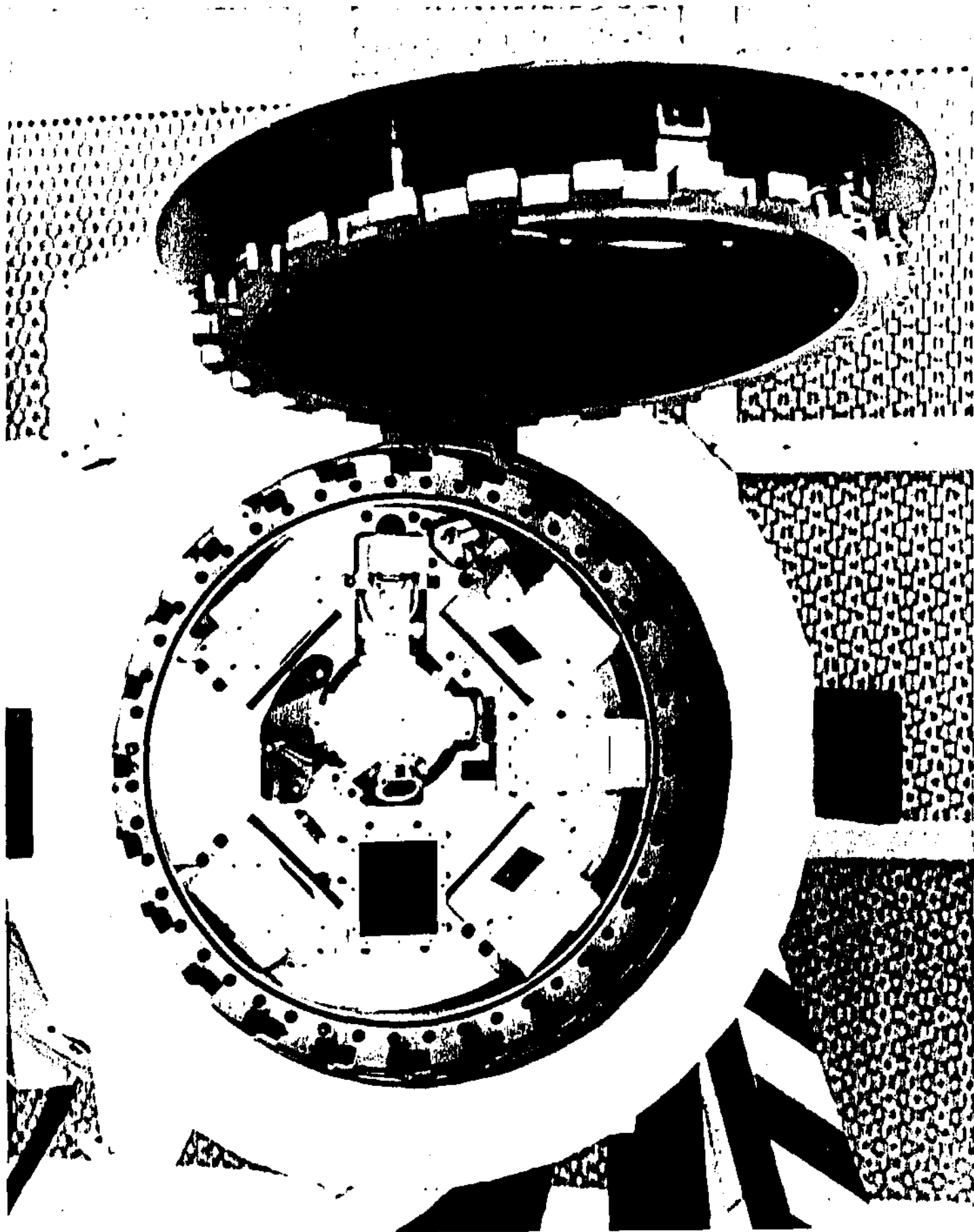

Figure 9: Close up view of front deck of the SSBUV.

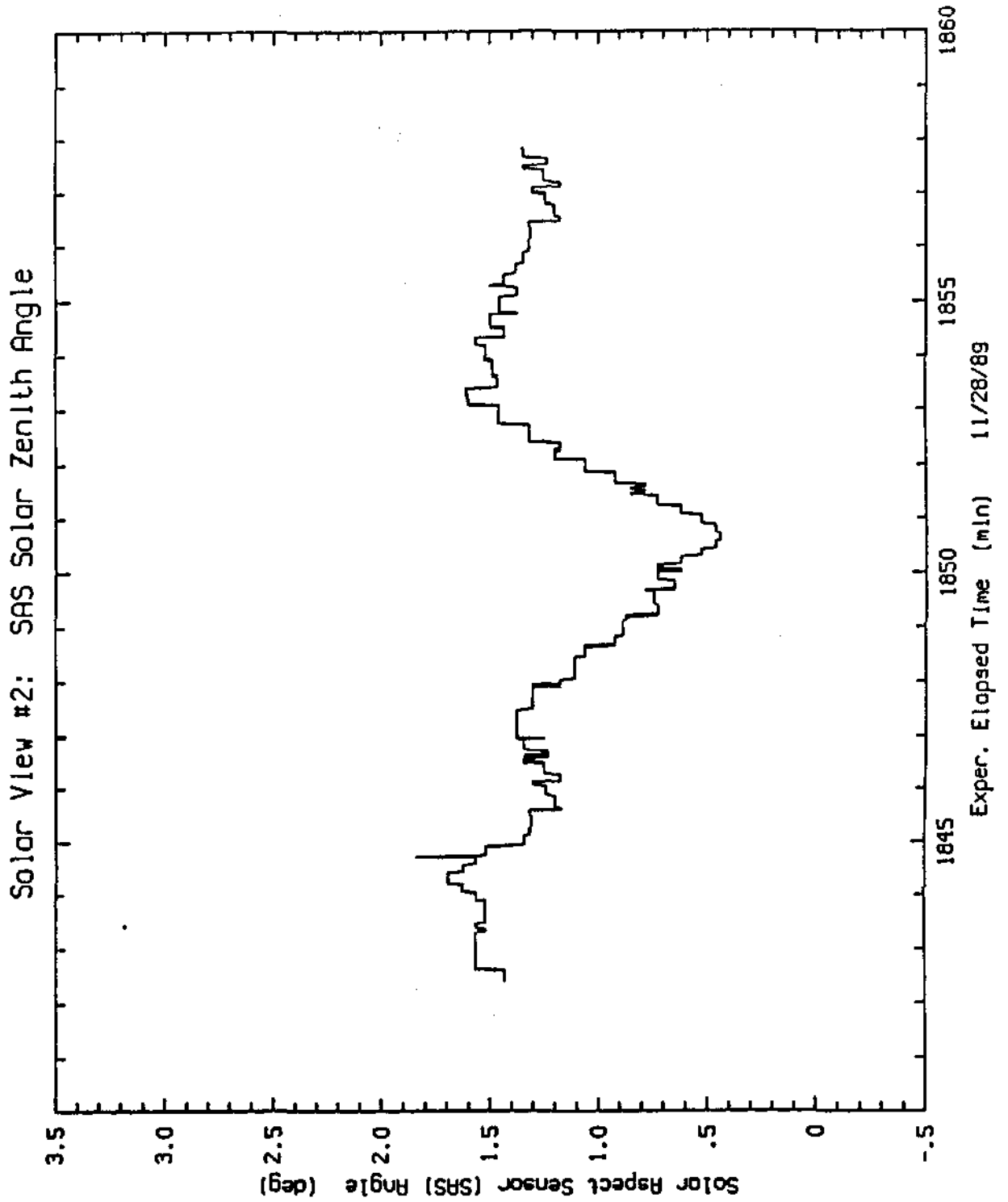

Figure 10: Sun angle versus time during sun viewing phase.

5584V-1:

Solar View #2: Solar Location In FOV

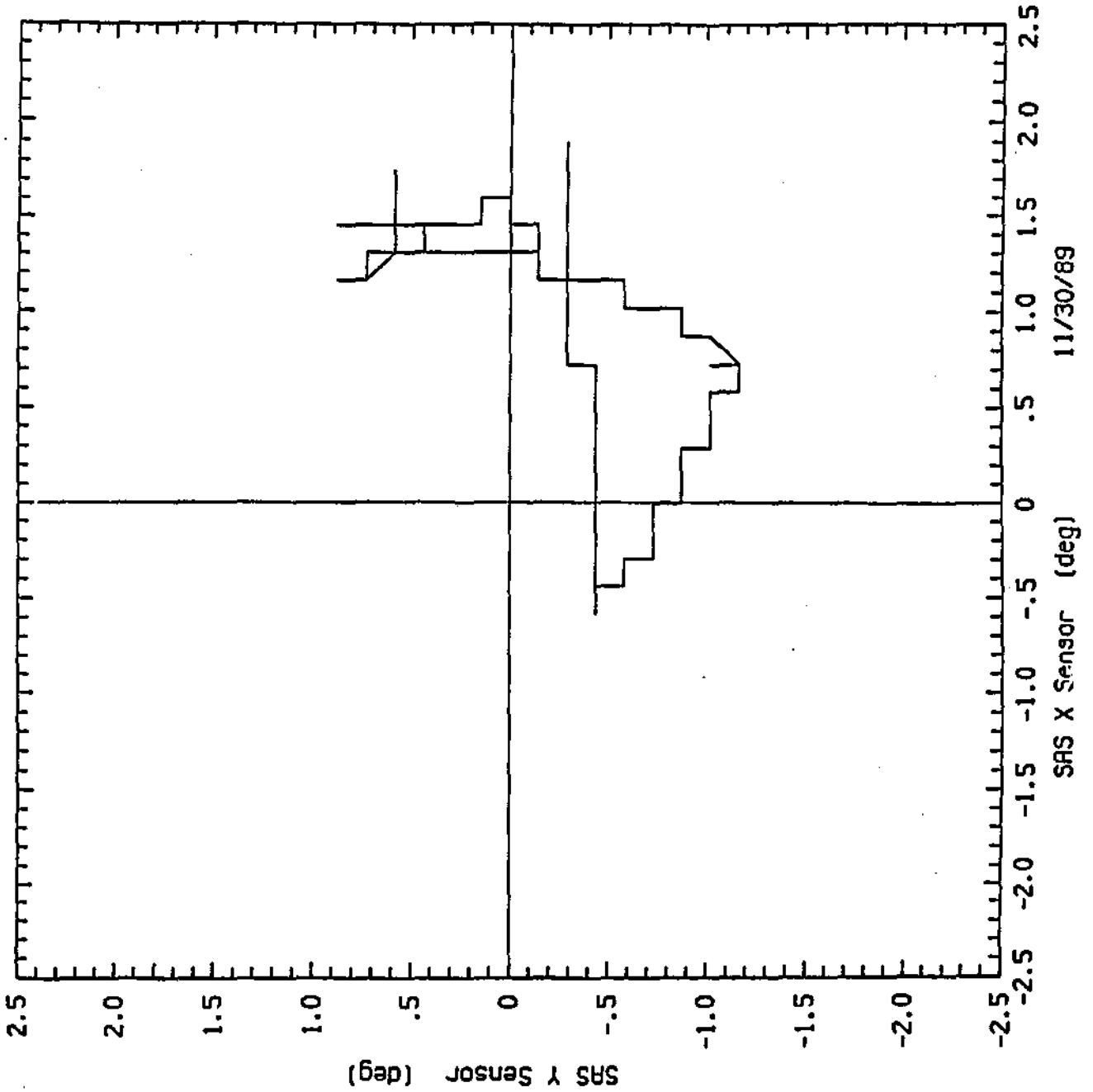

Figure 11: Cartesian coordinates (xandy) of sun angle versus time.

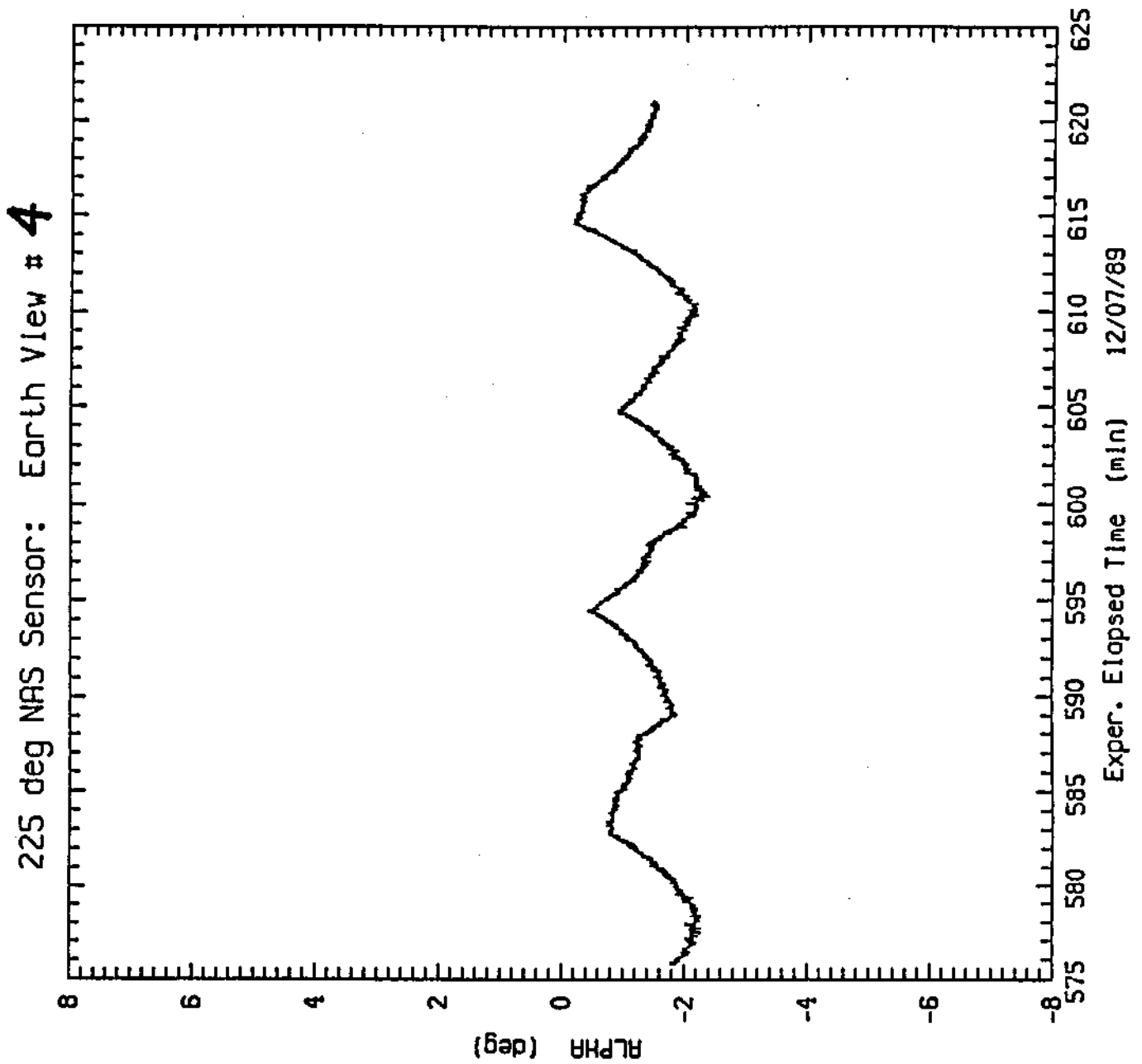

Figure 12: Horizon angel versus time during Earth viewing phase.