



Micro Sun Sensor with CMOS Imager for Small Satellite Attitude Control

Keisuke Yoshihara, Hidekazu Hashimoto, Toru Yamamoto, Hirobumi
Saito, Eiji Hirokawa, Makoto Mita

Japan Aerospace Exploration Agency

Kota Magoshi
Magoshi Corp.

19th ANNUAL AIAA/USU CONFERENCE ON SMALL SATELLITES

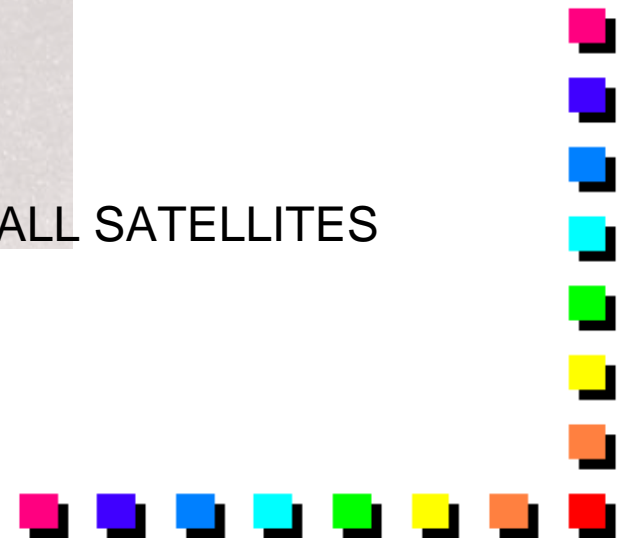
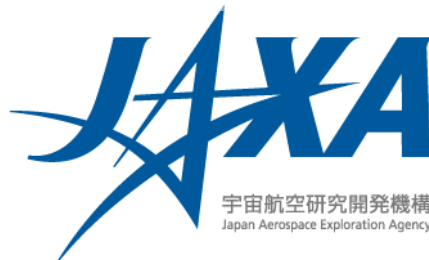

Contents

- **Introduction**
- **General description of the MSS**
 - **Concept**
 - **Functionality and Architecture**
 - **Design target and Current Status**
- **Substantial test results**
 - **Radiation test for COTS APS**
 - **Optical performance test**
- **Summary**

Introduction

- **JAXA's research and development program for next generation small satellite bus technology**
 - On-board computer, attitude sensor, reaction control system etc...
 - Newly-developed components and subsystems are planned to be installed in the **MicroLabSat-II** for on-orbit demonstration.

Micro Sun Sensor

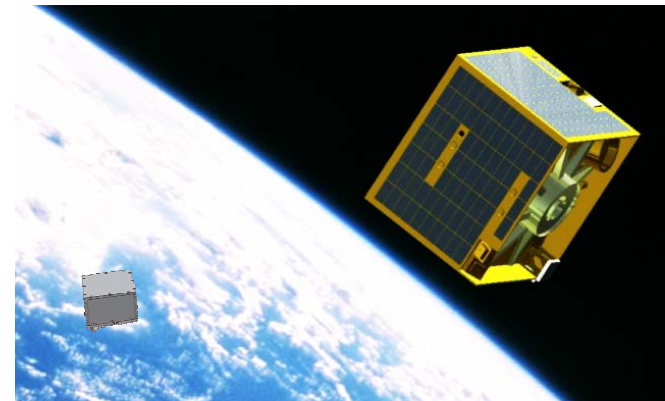
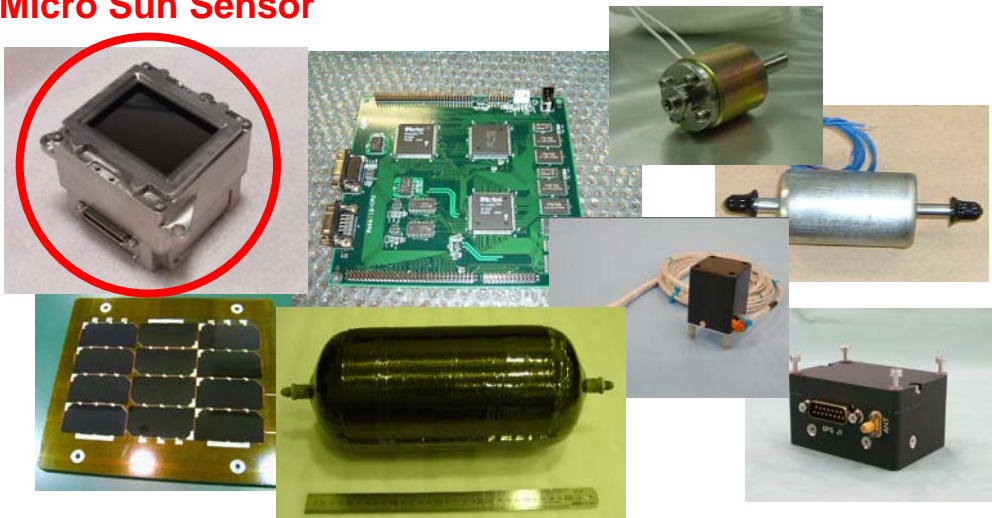

MicroLabSat-II

Concept of the MSS

The general concept of the MSS is to achieve **good balance** of size, mass, power consumption and performance.

■ Design concept of the MSS

- **Adoption of the CMOS APS as detector**

- MSS's simplicity and lower power consumption.

- **FPGA based signal processing**

- Simplicity and compactness of the digital electronics.

- Flexibility in the implementation of the signal processing.

- **Using COTS APS, optical filter and EEPROM**

- The state-of-the-art commercial parts are high performance and lower cost.

- Radiation hardness is not guaranteed is verified by radiation test.

Concept of the MSS

■ Measurement principle

- Sunlight incident on the APS through a **cross-shaped slit**.
- The **coordinates of the intersection** of sun image are computed. (Centroid calculation acquires sub-pixel resolution and accuracy)
- **Two axis solar aspect angle** is derived from the intersection coordinates.

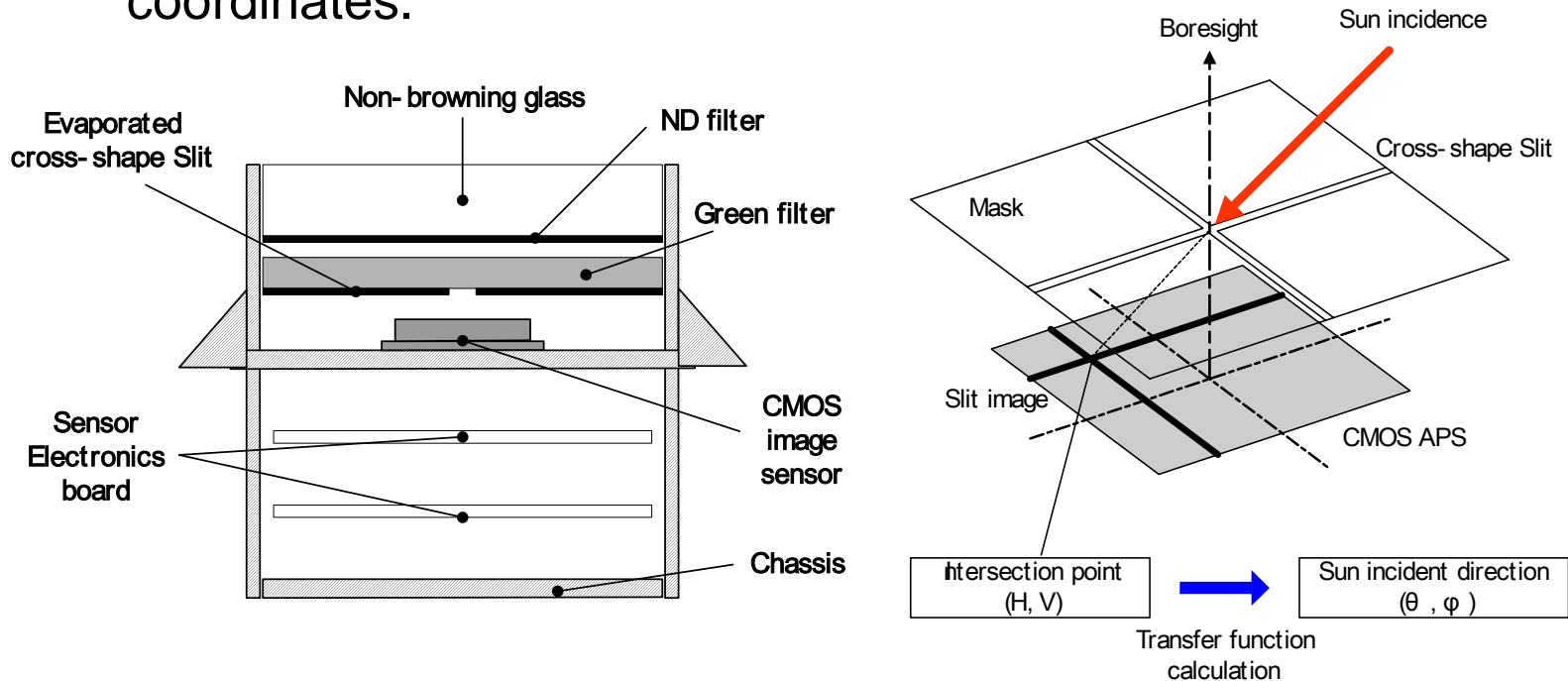

Functionality and Architecture

■ Function and technology

- Output of pixel coordinates of sunlight intersection for solar angle calculation in OBC.
- Raw pixel data output for APS test.
- Direct access (read/write) to ROM and RAM.
- Overcurrent detection and reconfiguration.

■ Electronics architecture

- Signal processing and command /telemetry handling functions are implemented in a single FPGA.
- CMOS/TTL serial data interface. (RS-422 is also available)

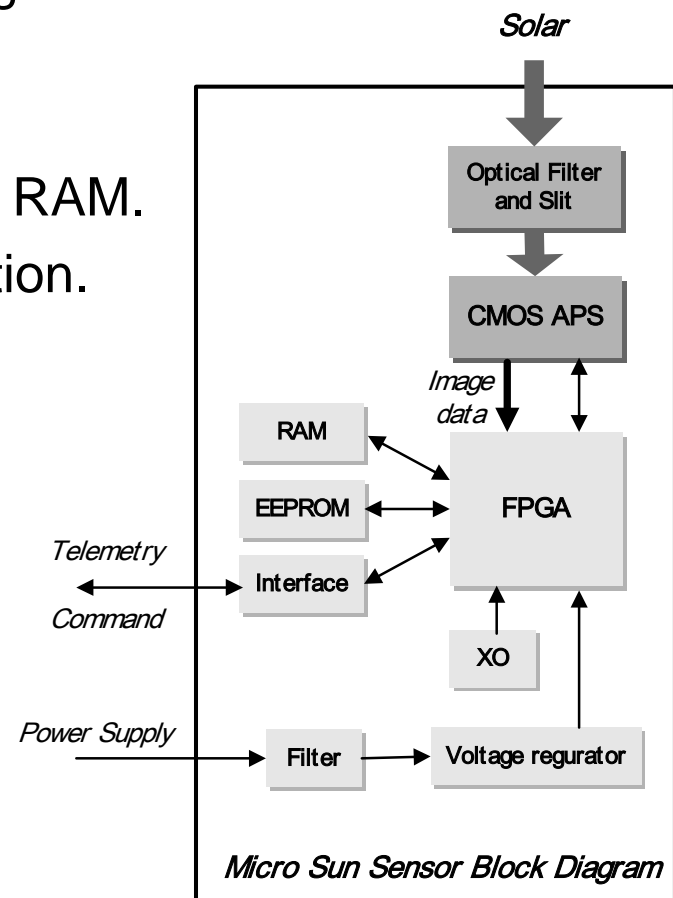

Design Target and Current Status

■ Design Target

Item	Specifications
Dimension	60mm(W) * 60mm(D) * 60mm(H)
Mass	330g
Power	5VDC, < 1.5W (nominal)
FOV	90×90deg
Performance	<0.1deg (bias error, 3sigma) <0.01deg (random error, 3sigma)

■ Status

- Ground Test Model (GTM) was fabricated and tested.
- **GTM satisfies all MSS's design target.**

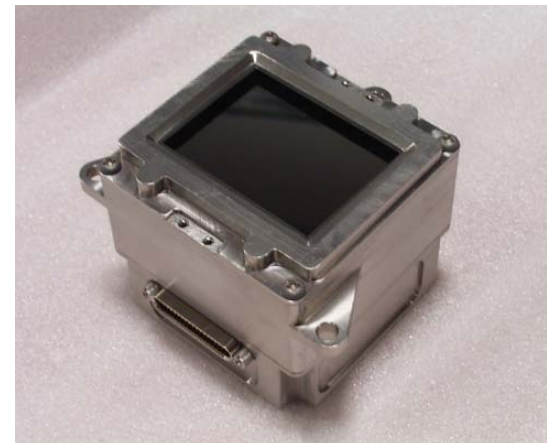

Radiation Test for Commercial APS

■ Gamma rays irradiation test with Co60

- The APS operated normally and did not lose any function in 25krad expose.
- The dark current level was increased after gamma irradiation and recuperated after annealing.
- The reduction of the sensitivity was not identified.

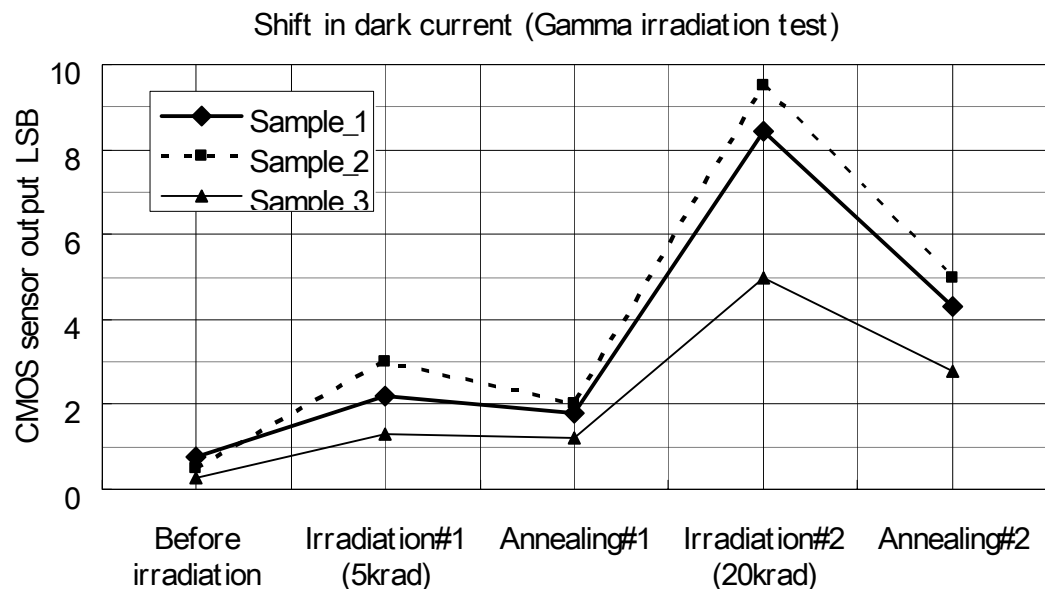

Radiation Test for Commercial APS

■ Proton irradiation test

- The APS operated normally and did not lose any function in 25krad expose.
- The increase of the dark current level and pixel-to-pixel variations of the dark current were identified.
- Some recoveries out of degradation were confirmed after annealing.
- The reduction of the sensitivity was not identified.

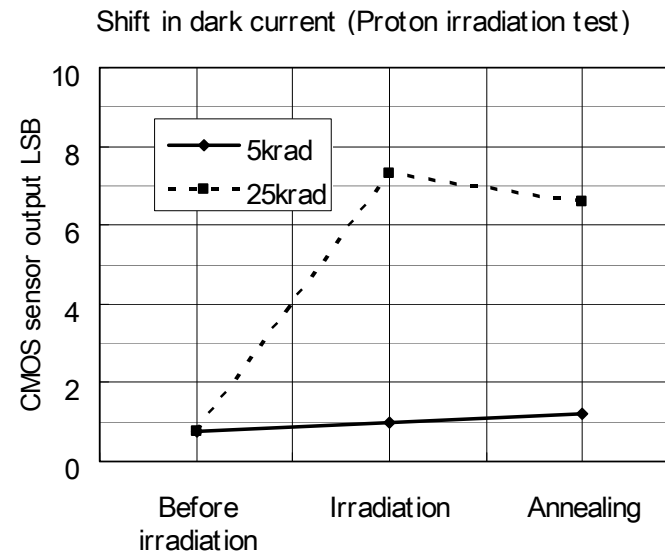

Radiation Test for Commercial APS

■ Summary of the radiation tests

- Minor degradation of several optical characteristics of the APS was identified in gamma and proton irradiation test.
- However the MSS is expected to maintain all functions and necessary optical performance in 25krad irradiation.

Optical Performance Test

Objective

- To evaluate the accuracy (bias and random error) of the MSS over the whole FOV.
- To defined “**transfer function**”.
- To evaluate the effect of spin rate on the performance of the MSS.

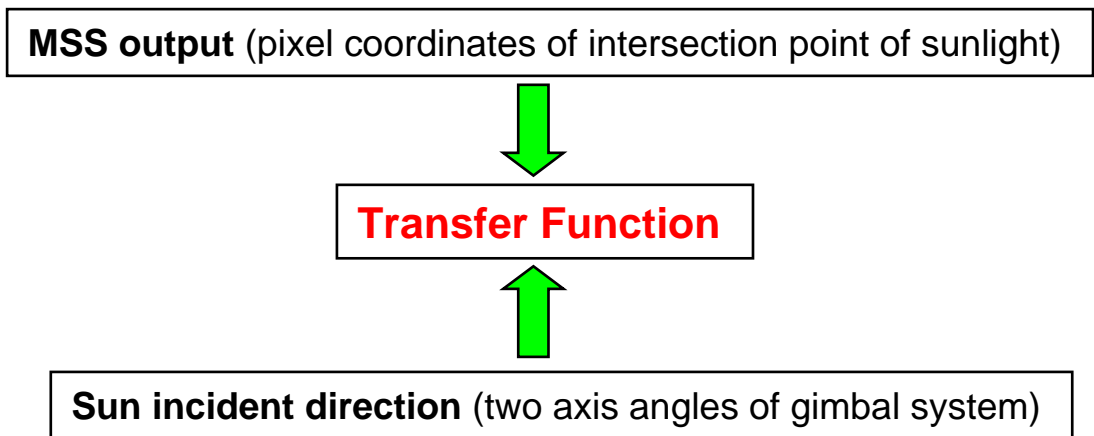
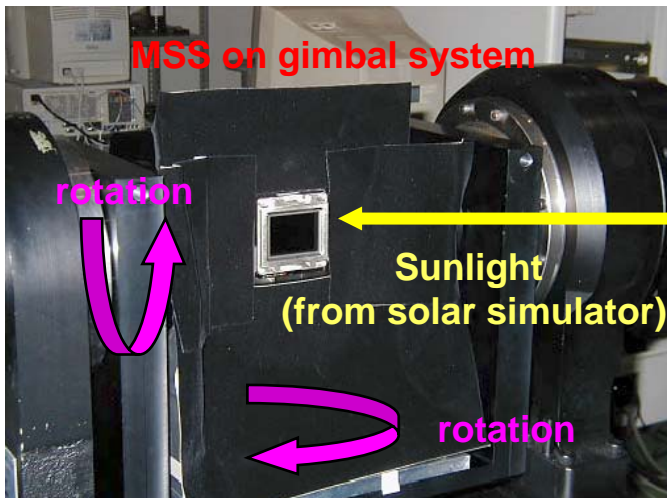

Optical Performance Test

■ Bias error evaluation

- Bias error satisfied the target specification (<0.1deg) over whole FOV.

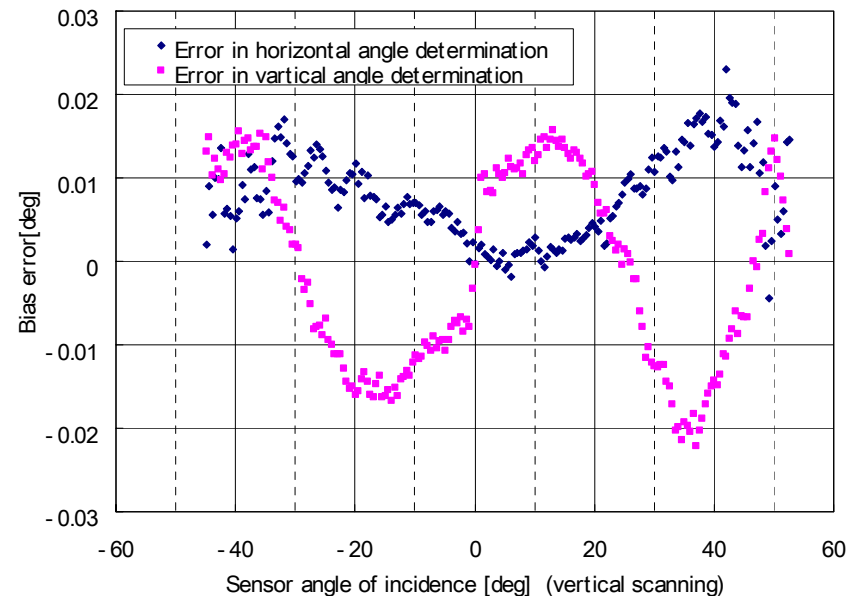
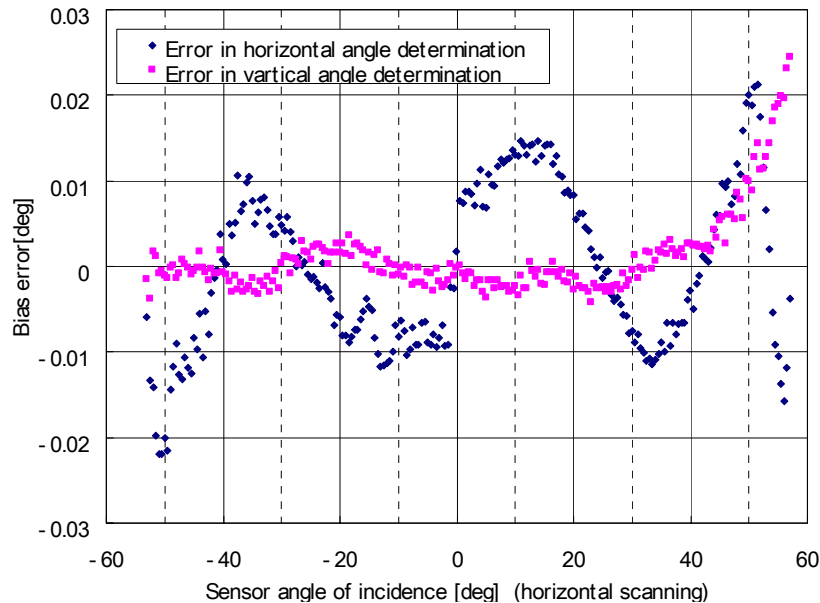

Optical Performance Test

■ Random error evaluation

- The random error is associated with the strength of the sun incidence.
- Random error satisfied the target specification.

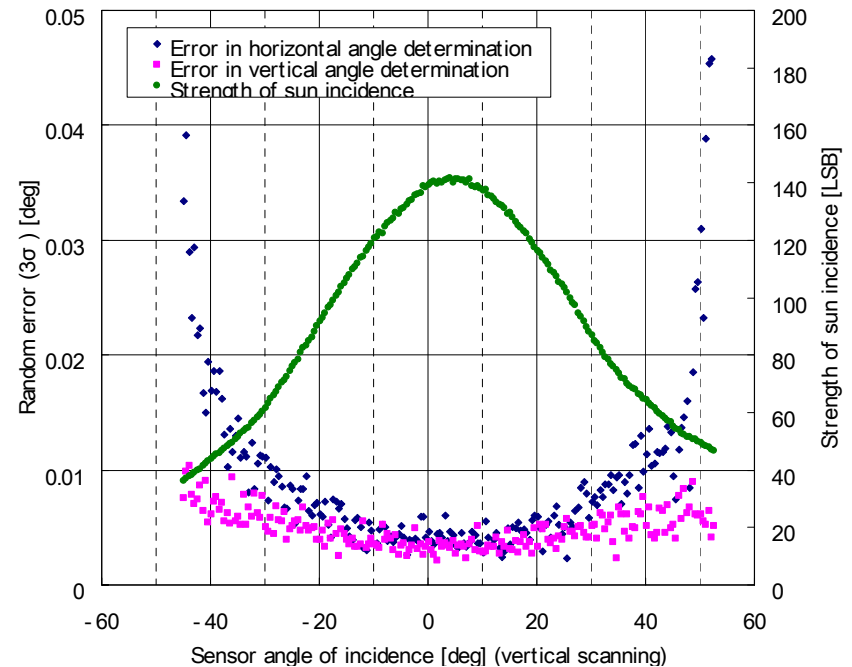
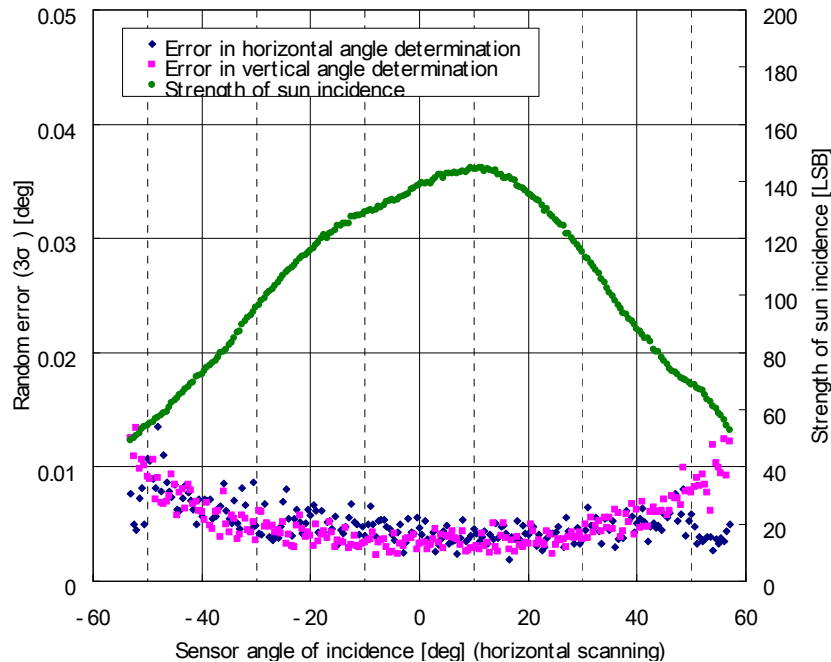

Optical Performance Test

■ Dynamic performance evaluation

- MSS data was acquired in the situation that the gimbal was rotating.
- Remarkable increase of the performance error was not identified in 6RPM.

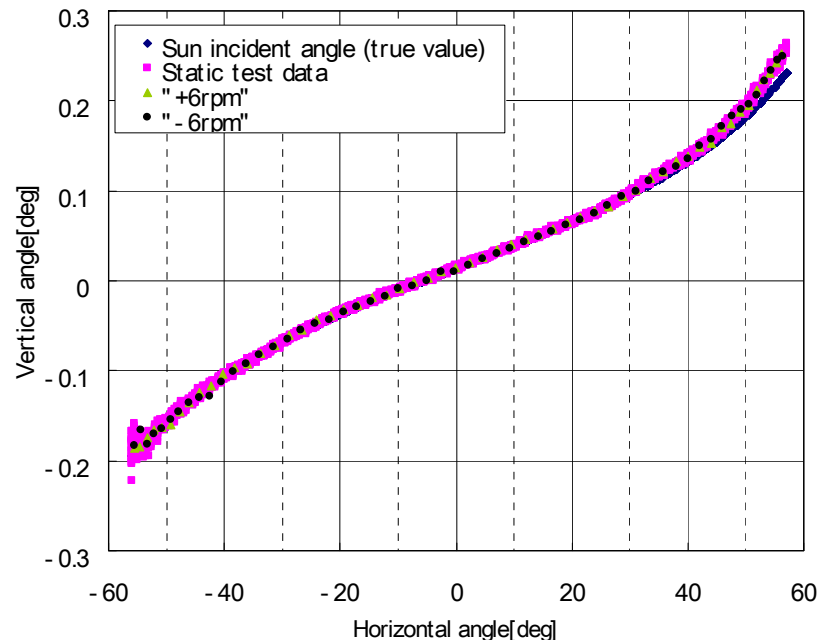

Optical Performance Test

■ Summary of the optical performance tests

- Both the bias error and the random error of the MSS satisfied the target specification.
- It was confirmed that the MSS can maintain its optical performance in the rate of 6RPM.

Item	Test result	Target value
Bias Error [deg] (3 sigma)	Horizontal < 0.045 Vertical < 0.045	< 0.1
Random Error [deg] (3 sigma ave.)	Horizontal < 0.009 Vertical < 0.0065	< 0.01

Summary

- **JAXA is developing the new type of Micro Sun Sensor.**
- **The MSS adopts a CMOS APS as a detector and a FPGA for signal processing.**
- **The GTM (Ground Test Model) of the MSS was fabricated and tested. The major design of the FM (flight model) could be established.**
- **The environmental tests for GTM are planned in this year. After the series of environmental test, the MSS FM will be stated to produce for the MicroLabSat-II.**

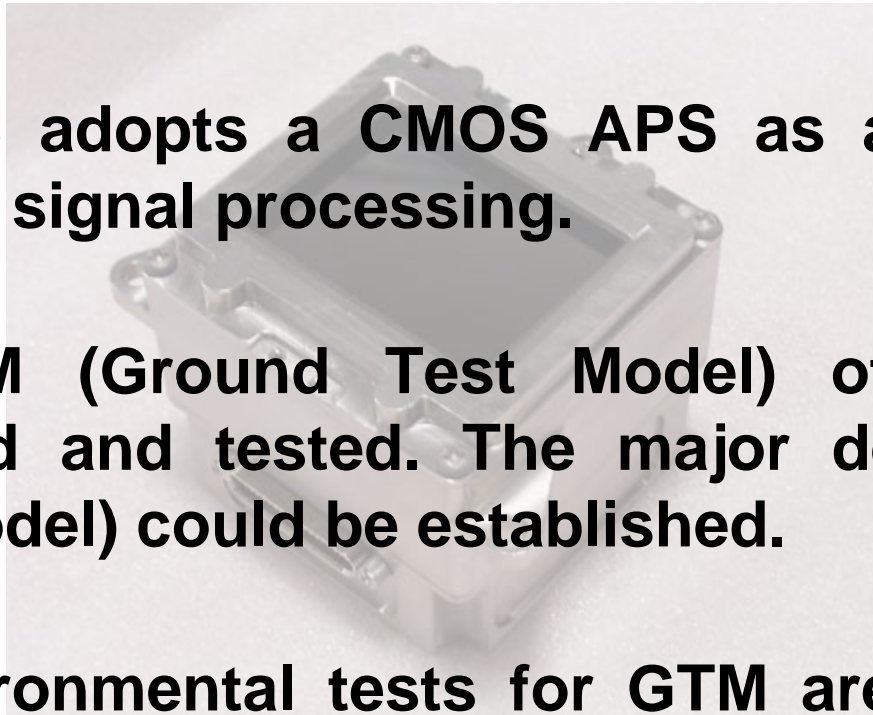

Thank you for your attention !

Small satellite activity in Japan

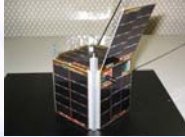
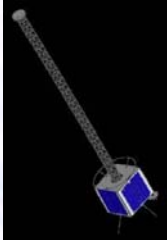
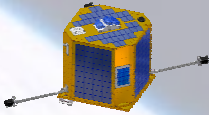
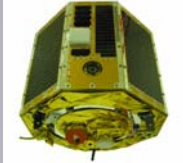
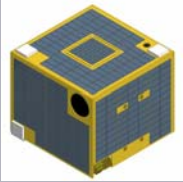
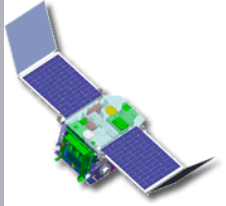
Name	Cubesat (XI)	Cubesat (CUTE-1)	WEOS	SOHLA-1	MicroLabSat	MicroLabSat 2	INDEX
							
Organization	Univ. of Tokyo	Tokyo Inst. of Tech.	Chiba Inst. of Tech.	SOHLA (SMEs union)	JAXA/ISTA/STDR	JAXA/ISTA/STDR	JAXA/ISAS
Mass	1kg	1kg	50kg	50kg	54kg	60kg	70kg
Main mission	Education, technology demo.	Education, technology demo.	Whale ecology observation	Training, technology demo.	Microsat bus demo, precursor mission, training	Advanced microsat bus and space technology demo, training	Aurora observation, engineering experiment
Launch	2003	2003	2002	TBD	2002	TBD	2005
STATUS	In operation	In operation	In operation	Under development	In operation	Under development	Preparing for launch

Furthermore, several small satellite projects are also being planned by other universities and organizations in Japan.

MicroabSat-II Satellite

■ Main characteristics

- 50kg-class micro-satellite
- Earth oriented 3-axis attitude control
- Carry and release a nano-satellite on orbit

Item	Characteristics
Size	600(W)×600(D)×500(H)mm 200(W)×200(D)×150(H)mm(NanoSat)
Mass	60kg(Total), 5kg(NanoSat)
Power	100W
Attitude	Earth oriented 3-Axis control
Comm.	Micro LabSat II ↔ Ground Station: S-band, 4kbps(Up), 1.6Mbps(Down) NanoSat ↔ Ground Station: S-band Micro LabSat II ↔ NanoSat: TBD
Orbit	LEO, Sun synchronous
Launch	TBD (The completion of development < 2008)

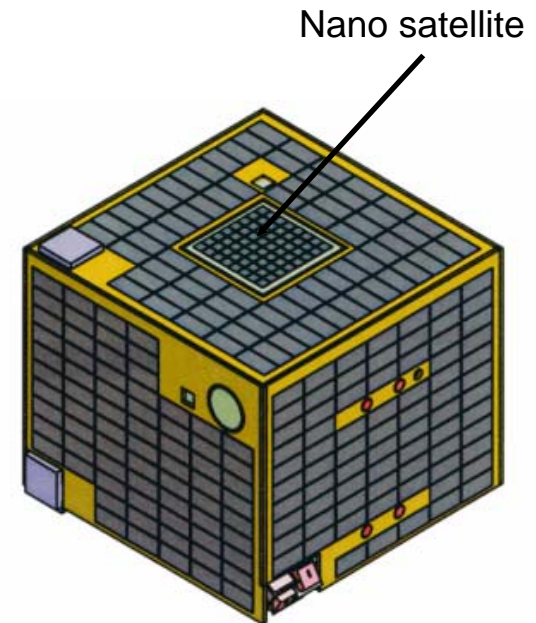

MicroLabSat-II image

Experiment in collaboration with NanoSat

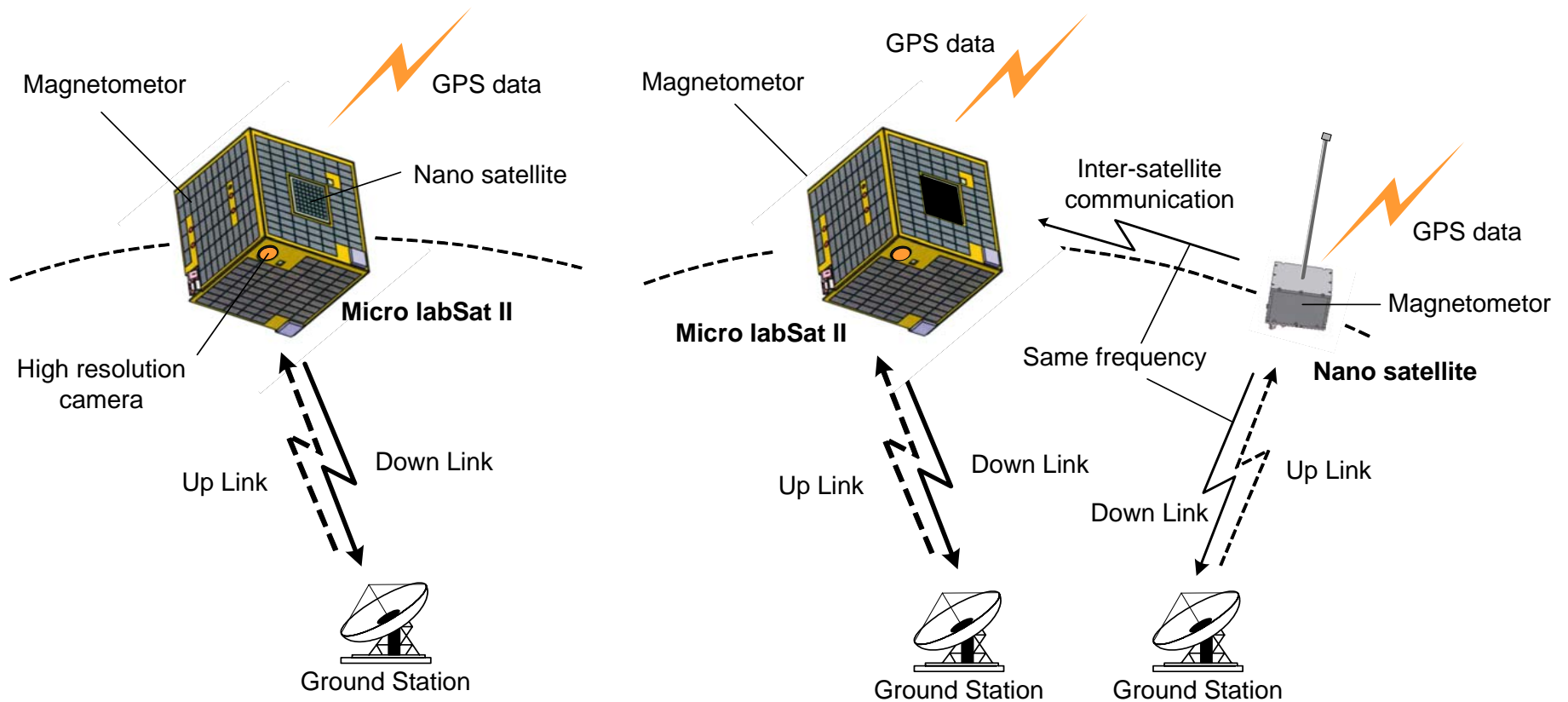

Before release nano satellite

Experiment image in collaboration with nano-satellite